



SPPIN | SAINTS-PERES
Paris Institute for
the Neurosciences

Synaptic Plasticity : Spike-timing dependent plasticity (STDP)

Sep 25th, 2020

Michael Graupner (PhD)

michael.graupner@parisdescartes.fr

Saints-Pères Paris Institute for the Neurosciences

CNRS UMR 8003, Université de Paris

slides on : <https://www.biomedicale.parisdescartes.fr/~mgraupe/teaching.php>

Cerebellum and locomotion

Cerebellum ensures that movements are well timed and highly coordinated.

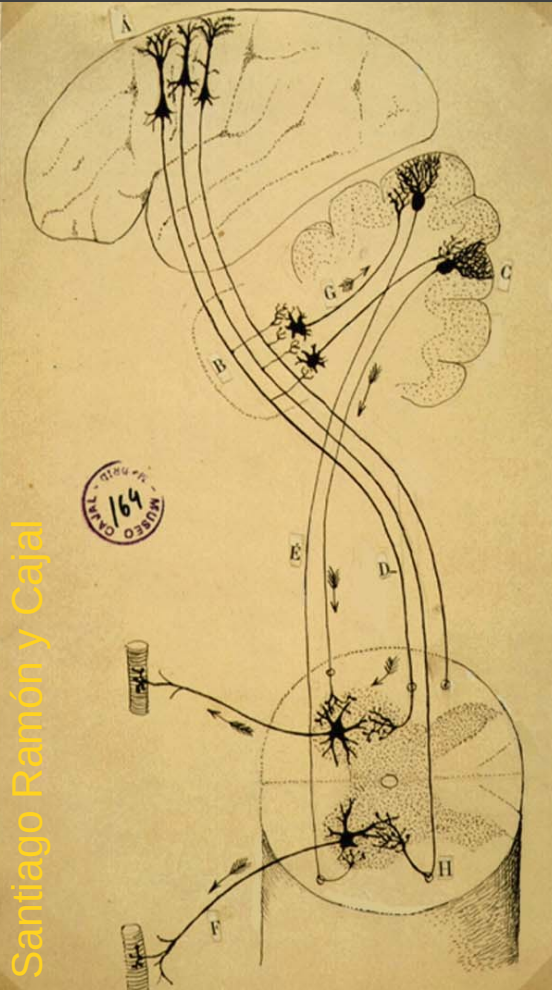

Cerebellum and locomotion

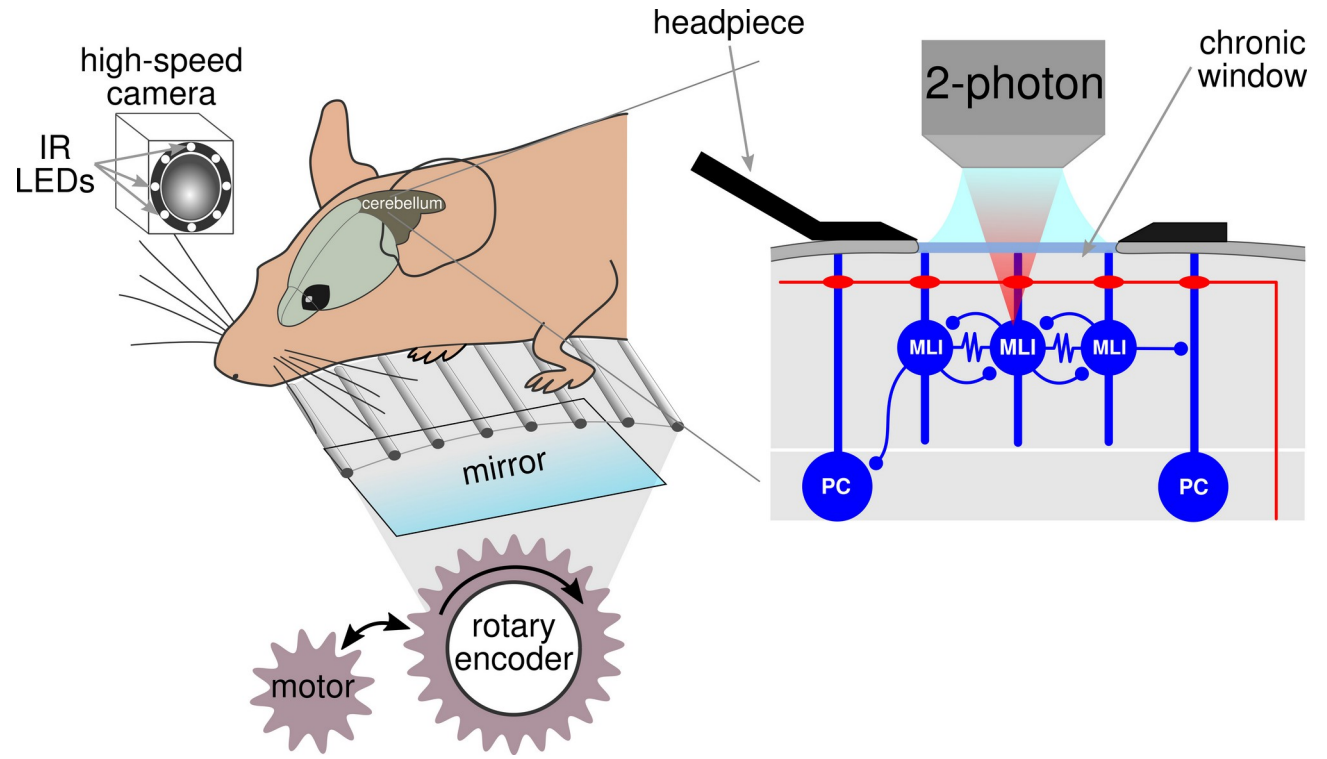
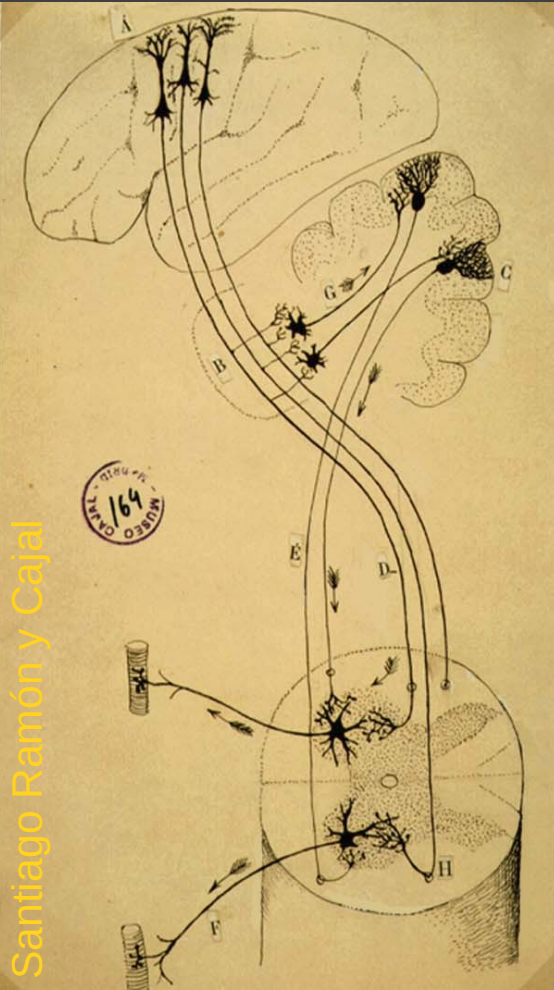

Students are welcome !

At which university am I working ?

At which university am I working ?

**→ What happens in your brain when
you learn ?**

Learning on the neuronal network level

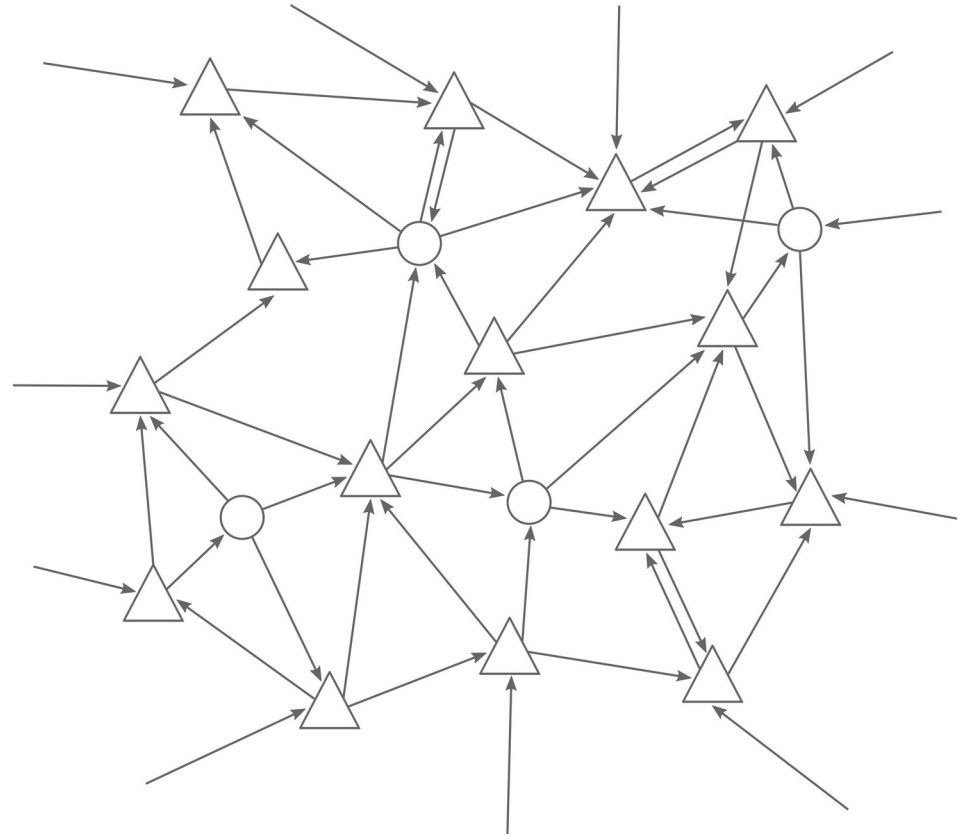

Learning on the neuronal network level

Stimulus / Experience

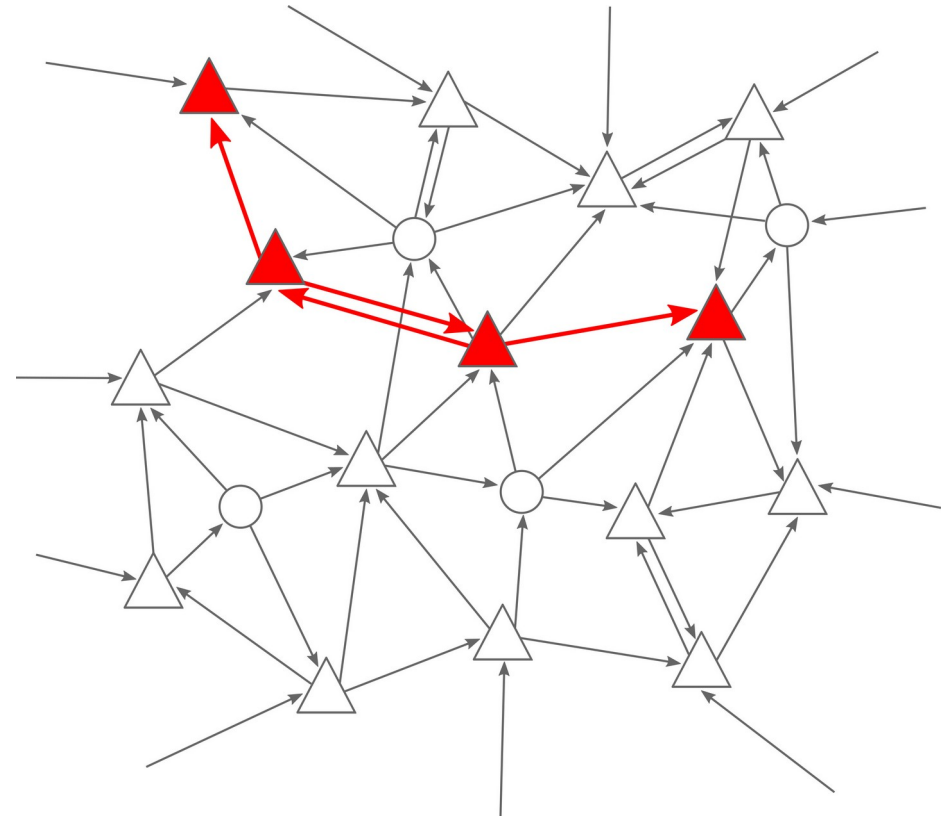

Learning on the neuronal network level

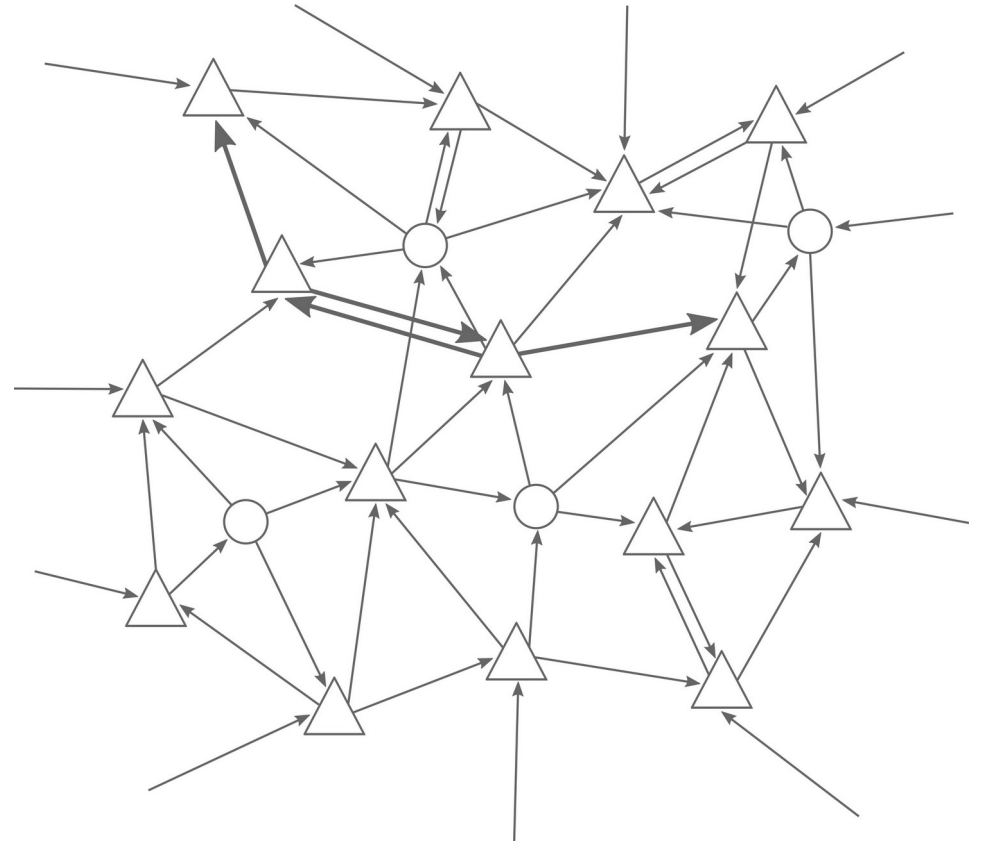

Focus of today's lecture

Which activity pattern leads to a change in the connection between the neurons ?

Which role does the timing of pre- and postsynaptic action potentials play ?

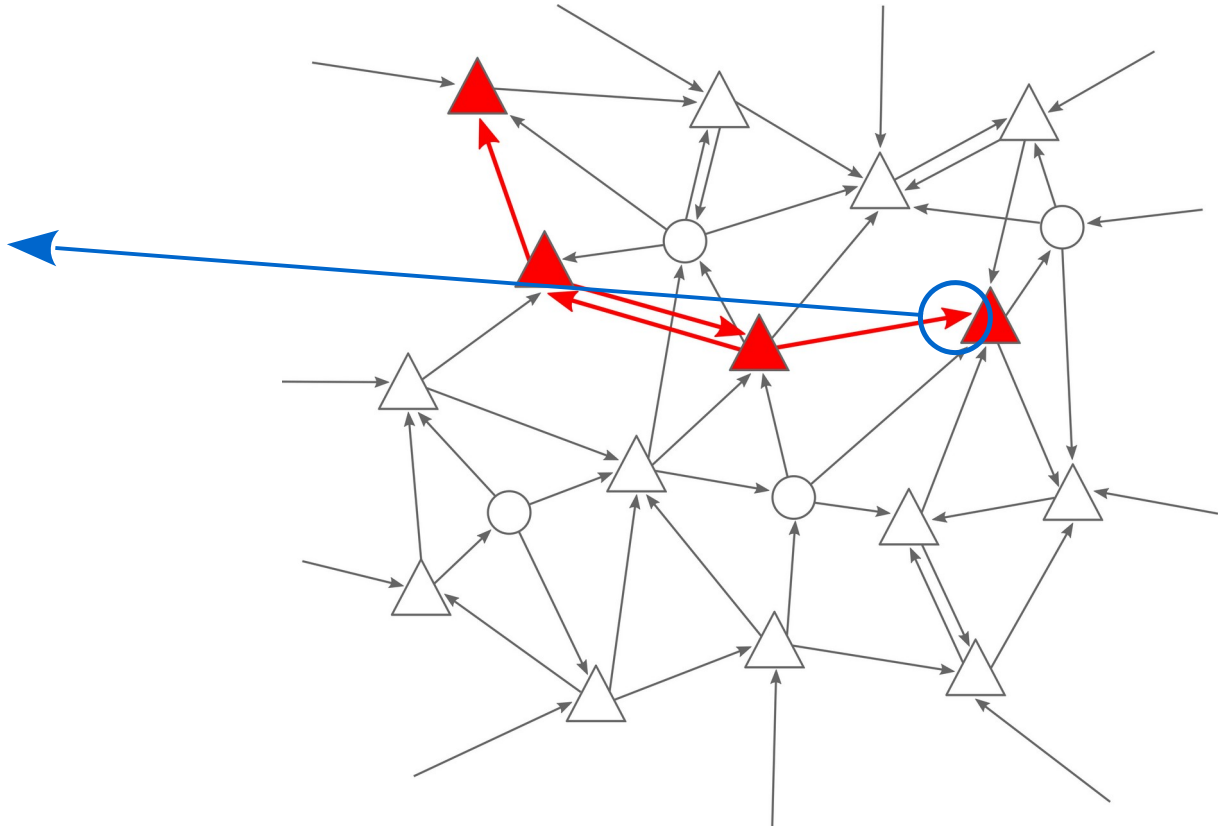

Experimental evidence : synaptic plasticity <-> memory

Morris water maze



[Morris *et al.*, 1986]

Relation between LTP and learning/memory

Control (saline)

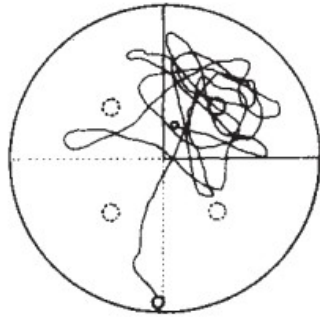

D,L-AP5 2133

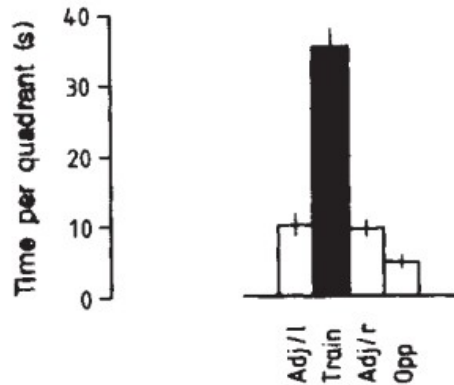
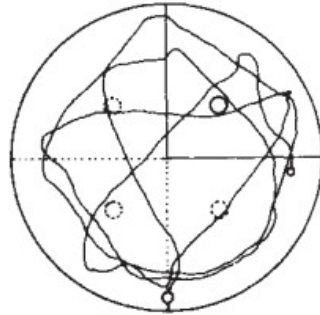

- NMDA receptor required to learn platform location [Morris *et al.*, 1986]
- NMDA receptor required to form spatial memories (place fields)

[McHugh *et al.* 1996]

Outline : STDP ... spike-timing dependent plasticity

1. STDP : introduction and history
2. Phenomenology of STDP
3. Induction mechanisms
4. Biophysical models of STDP
5. STDP *in vivo*

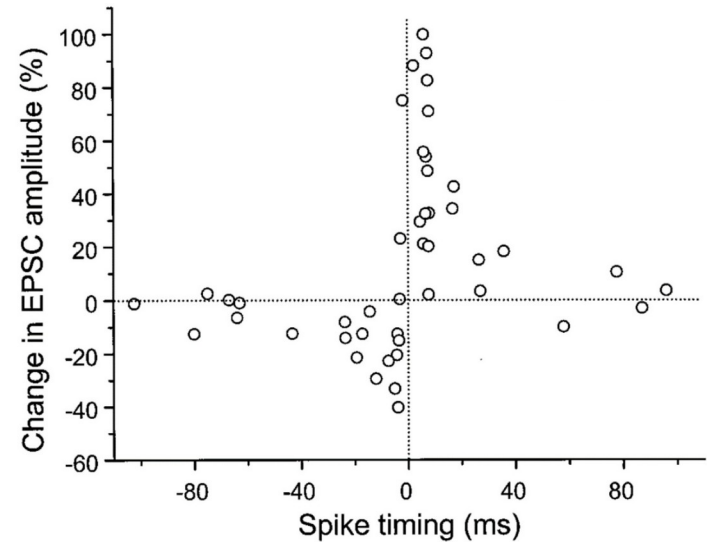

[Bi & Poo 1998]

Outline : STDP ... spike-timing dependent plasticity

1. STDP : introduction and history
2. Phenomenology of STDP
3. Induction mechanisms
4. Biophysical models of STDP
5. STDP *in vivo*

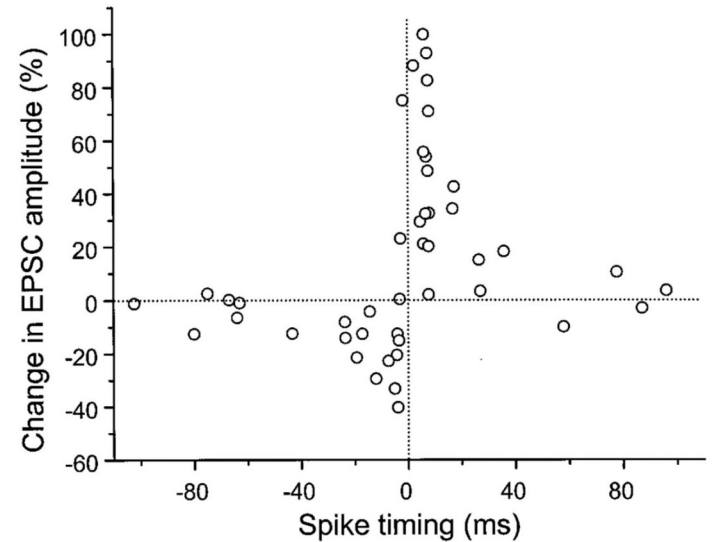

[Bi & Poo 1998]

Chemical synapse : transmits electrical signals

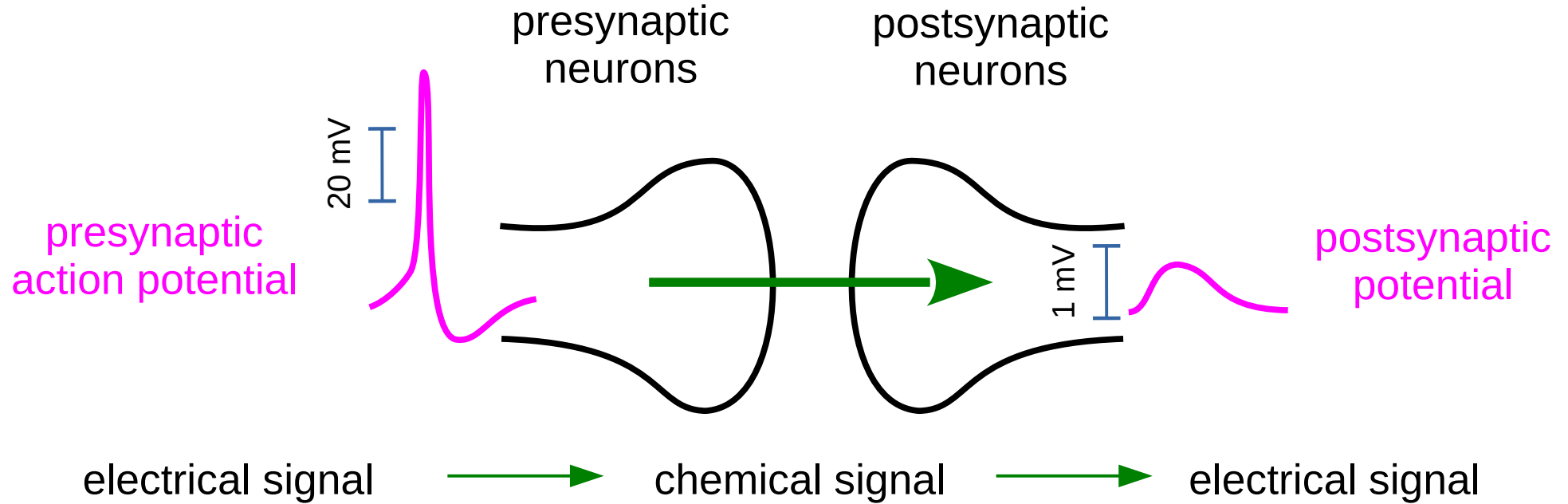

- directional transmission
- conversion of signals allows for flexibility/plasticity

Chemical synapse : underlying biological machinery

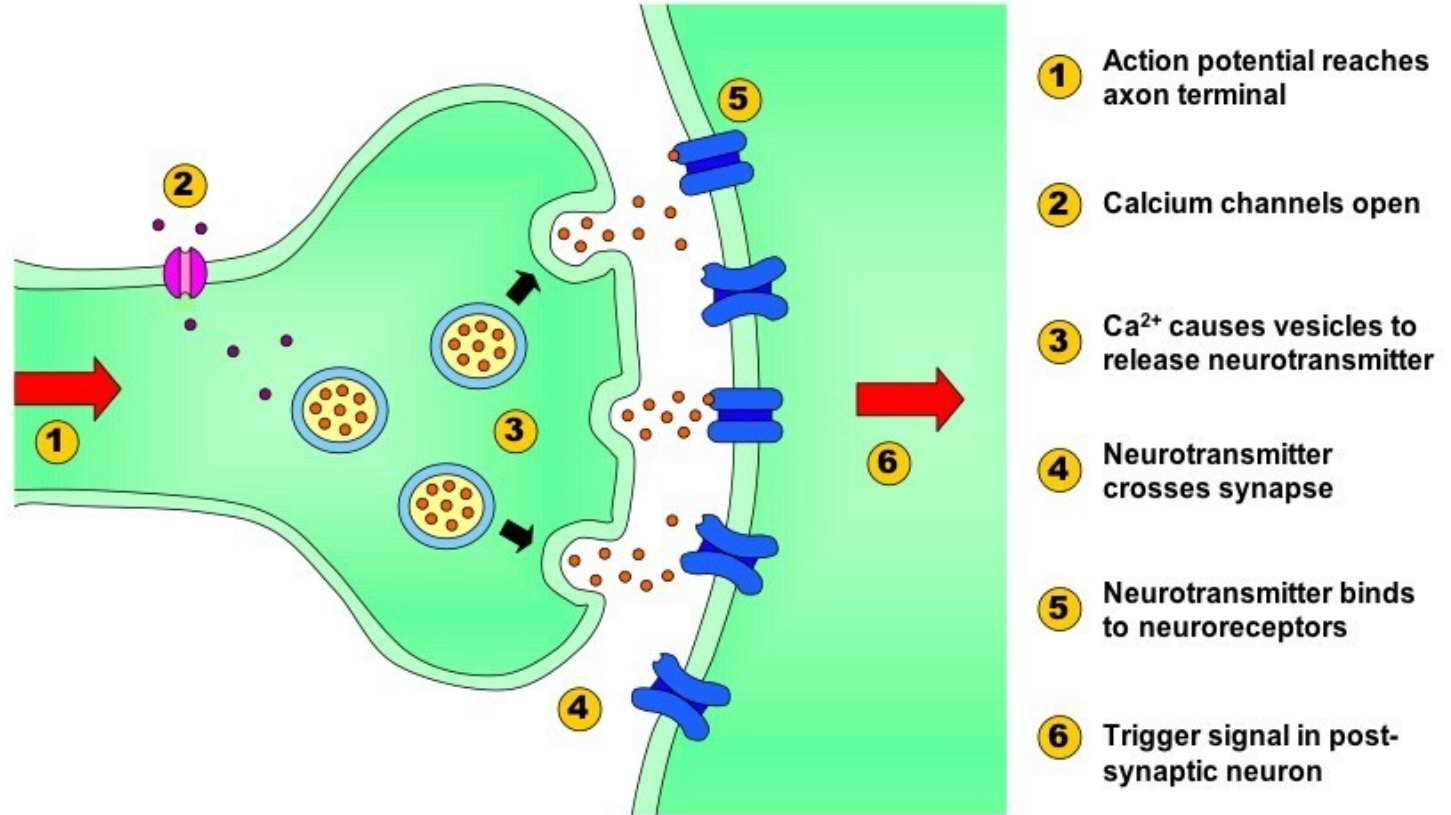

Chemical synapse : excitatory or inhibitory

Excitatory synapse

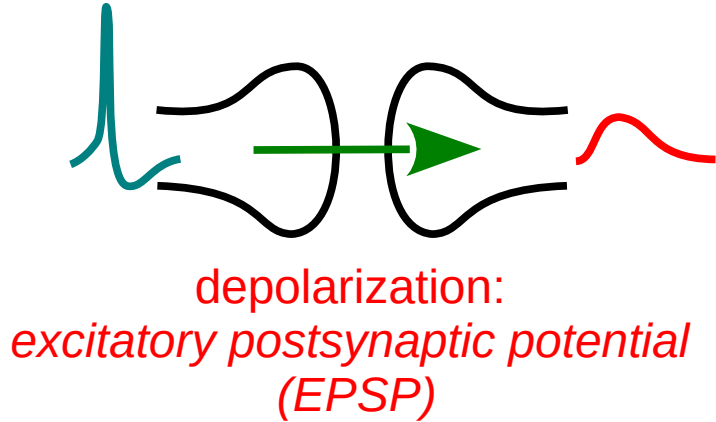

Inhibitory synapse

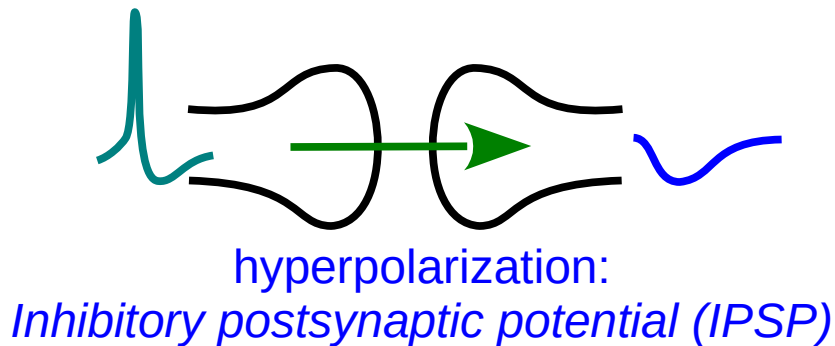

neurotransmitter	receptor
glutamate	AMPA, NMDA
acetylcholine	nAChR, mAChR
catecholamines	G-protein-coupled receptors
serotonin	5-HT ₃ , ...
histamine	G-protein-coupled receptors

neurotransmitter	receptor
GABA	GABA _A , GABA _B
glycine	GlyR

Different forms of plasticity

structure of neurons

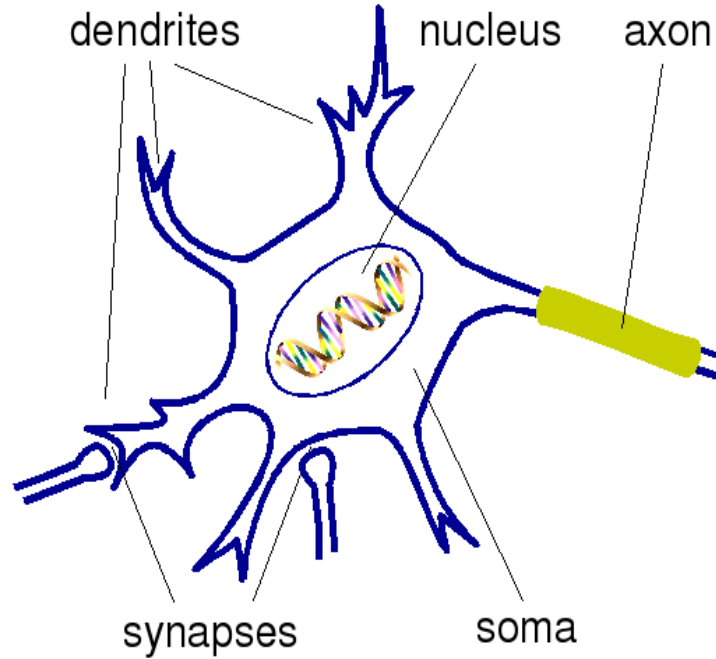

changes related to neural activity

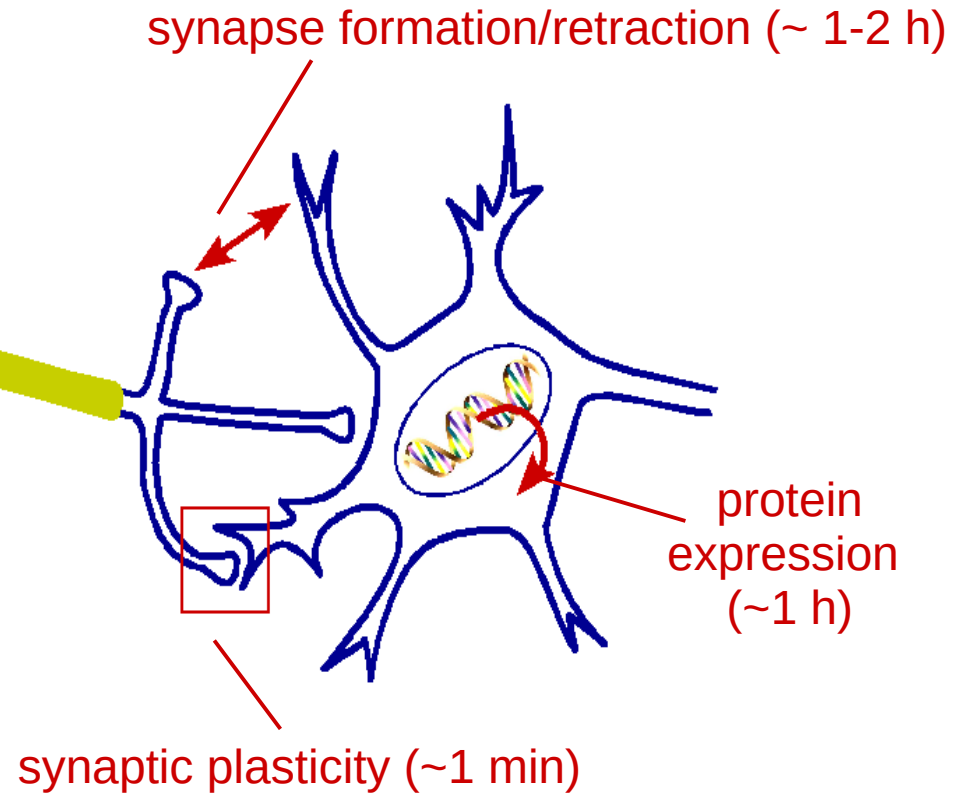

Short-term synaptic plasticity

train of presynaptic action potentials

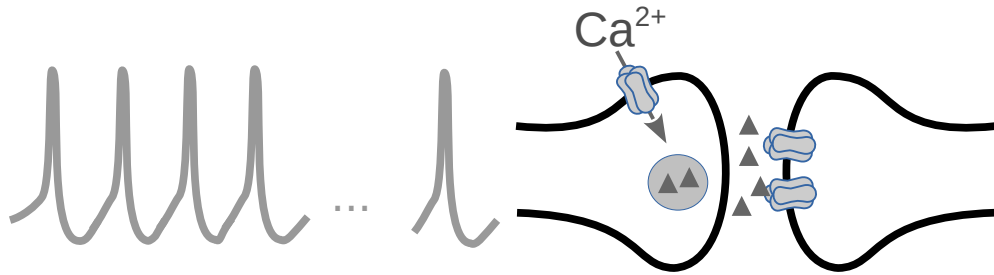

- transient change in transmission efficacy
- time scale of changes ~ 1 sec

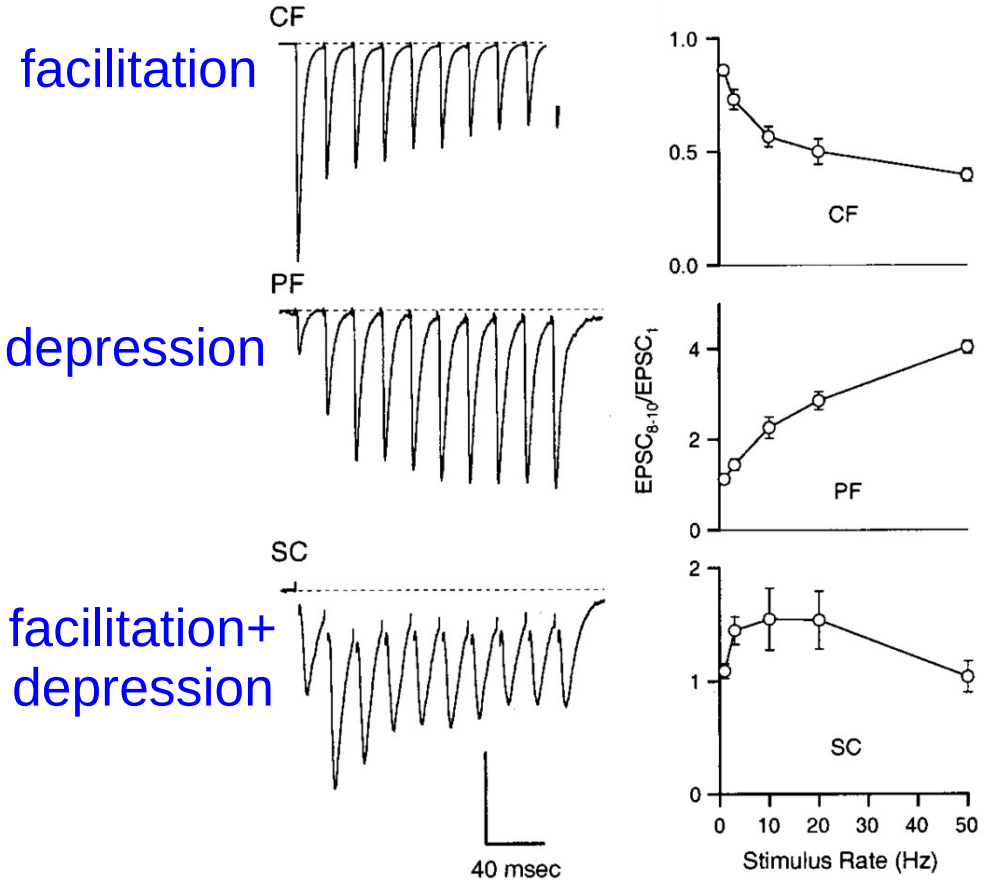

Long-term synaptic plasticity

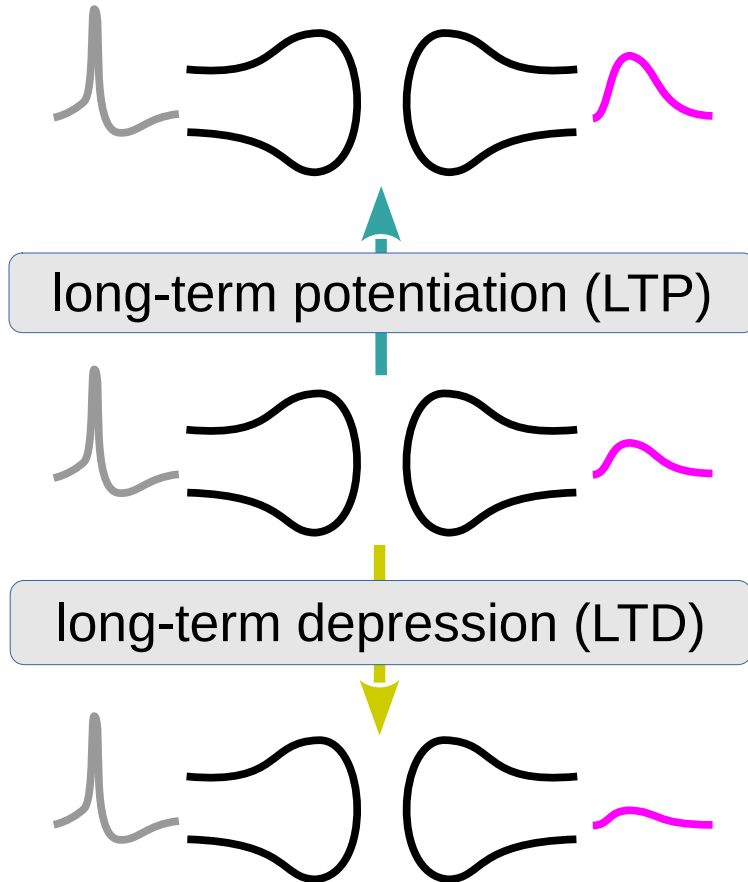

- long-lasting change (>60 min) in transmission efficacy
- time scale of induction ~ 1 min

Synaptic plasticity: induction, maintenance & states

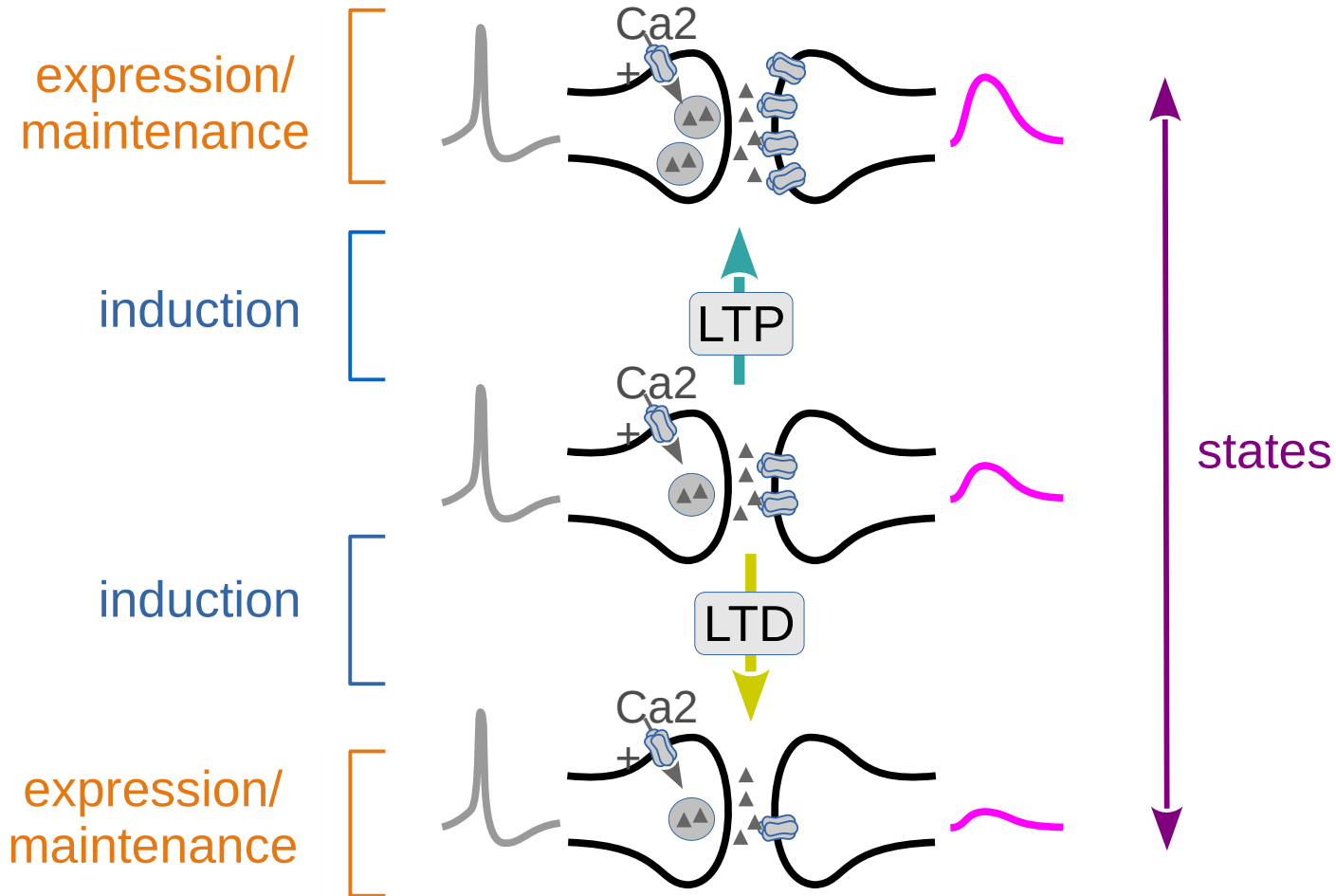

Spike timing : nomenclature

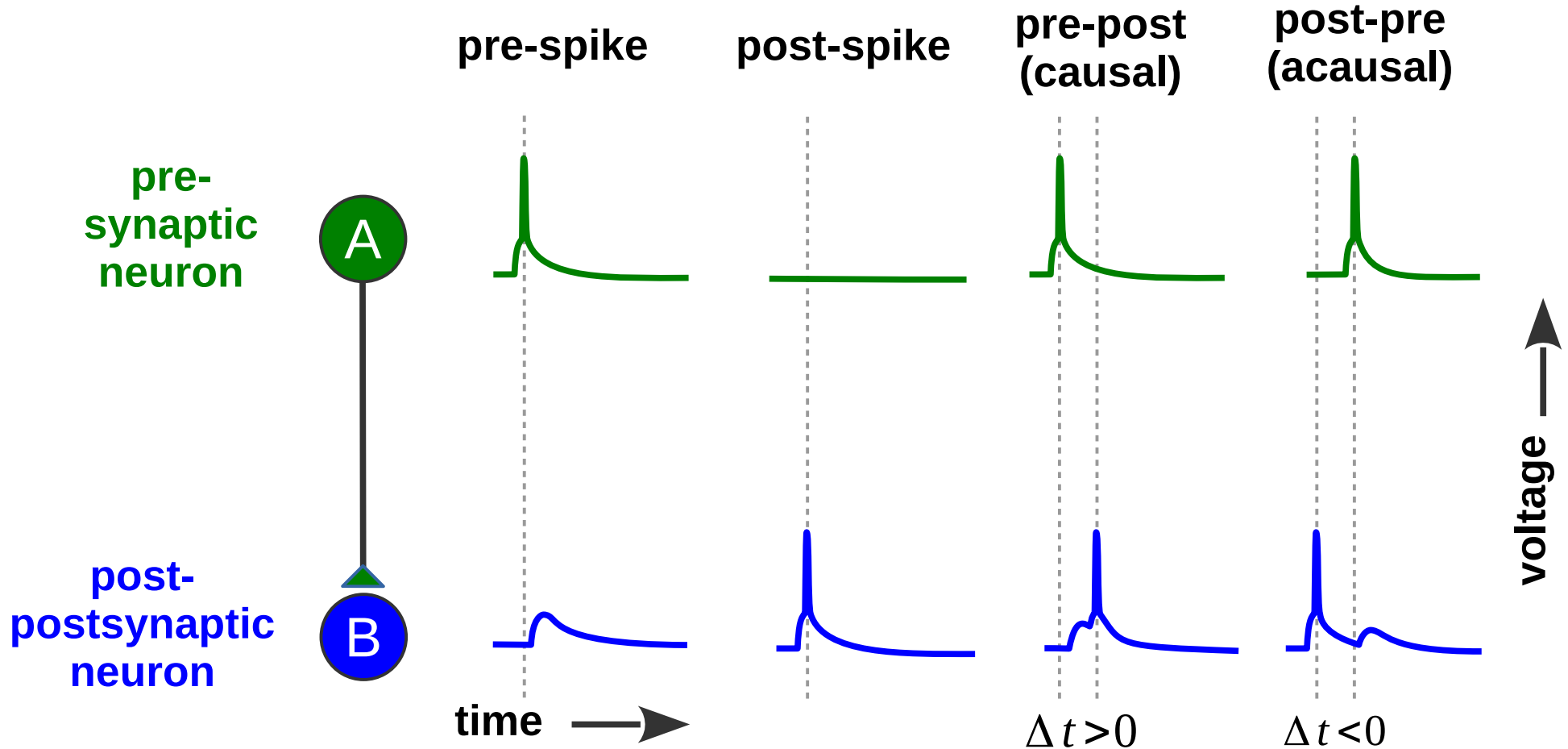

Spike timing : nomenclature

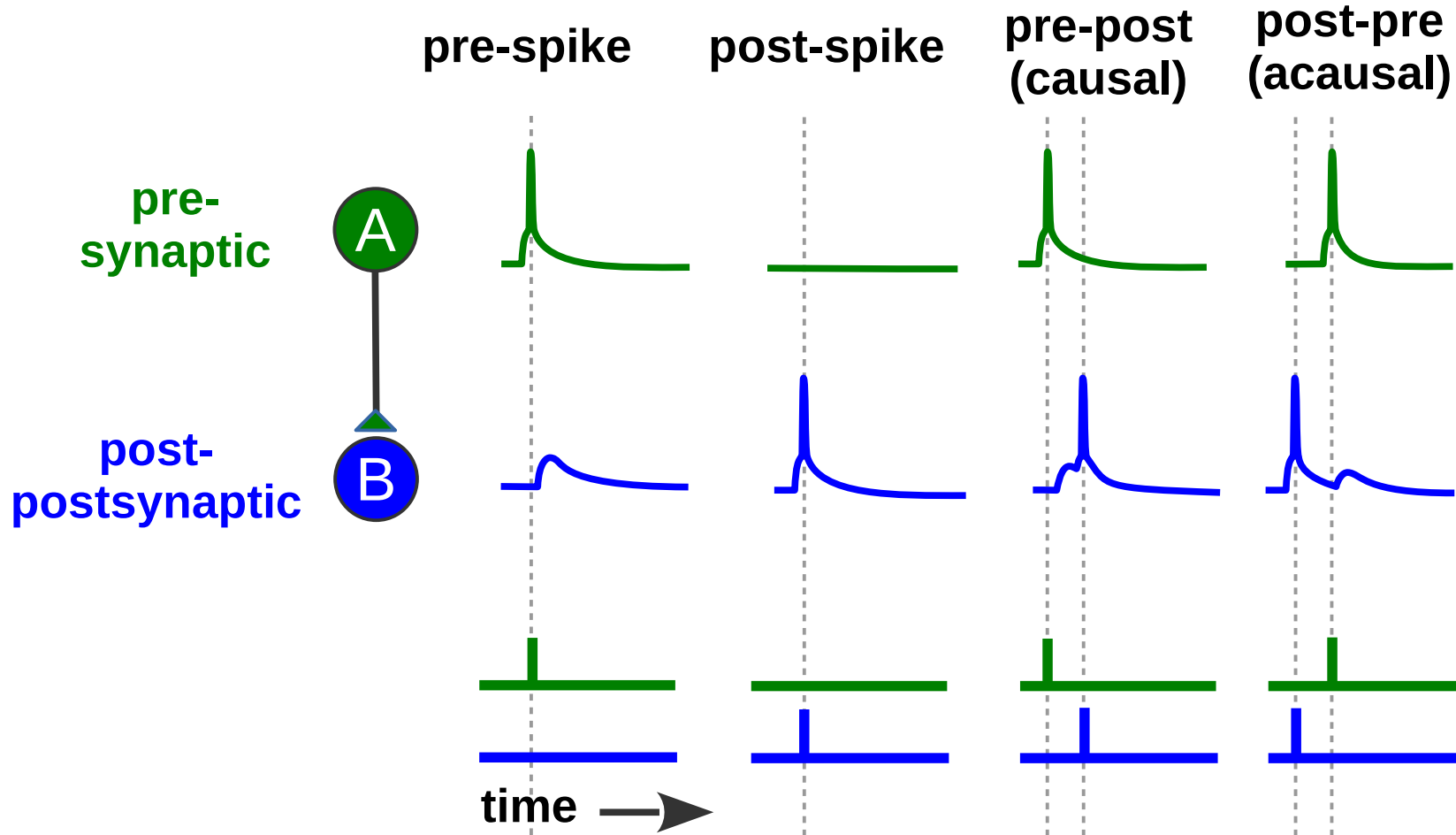

LTP induction: early conceptual work

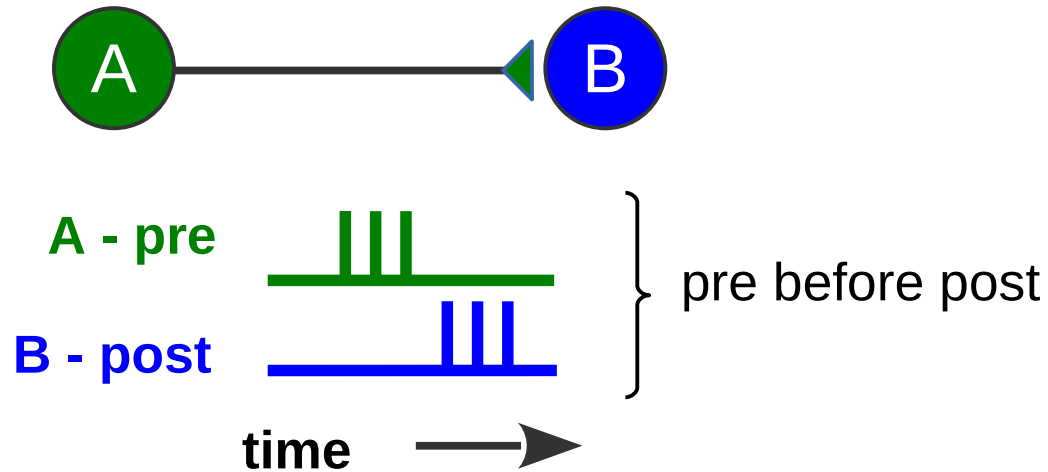

“When an axon of cell A is near enough to excite a cell B and *repeatedly* and *persistently* takes part in firing it, some growth or metabolic changes take place in one or both cells such that A’s efficiency, as one of the cells firing B, is *increased*.”

Induction: first experimental work in hippocampus

hippocampus

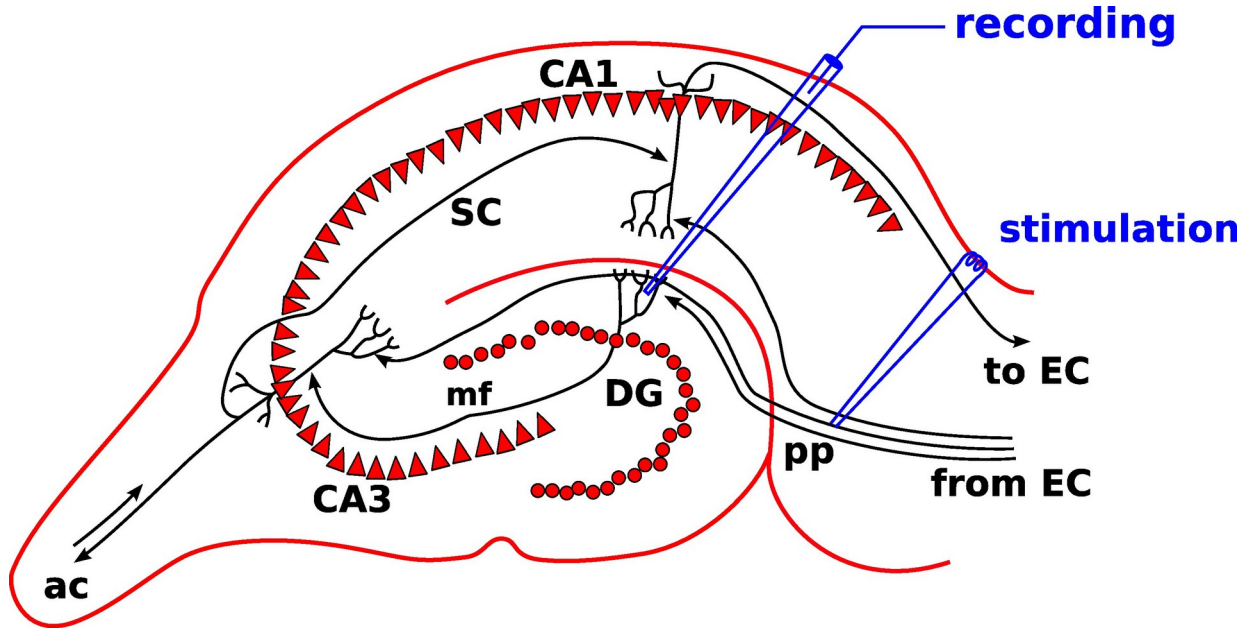

EC ... enthorhinal cortex
DG ... dentate gyrus
CA3/1 ... cornu ammonis 3/1

pp ... perforant path
mf ... mossy fibres
ac ... associational commissural path
sc ... Schaffer collateral

1. STDP : introduction and history

Induction: LTP through high frequency stimulation

hippocampus (*in vivo*)

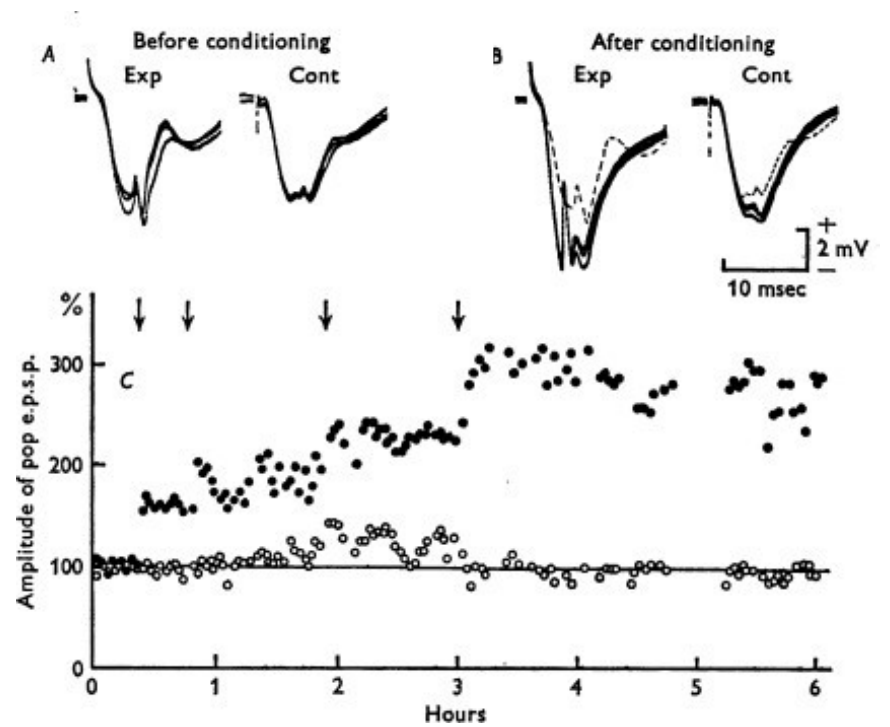
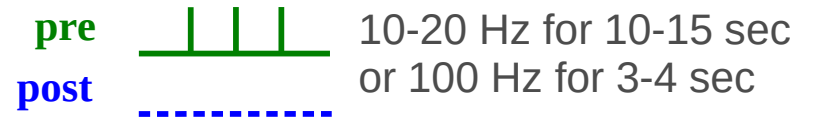
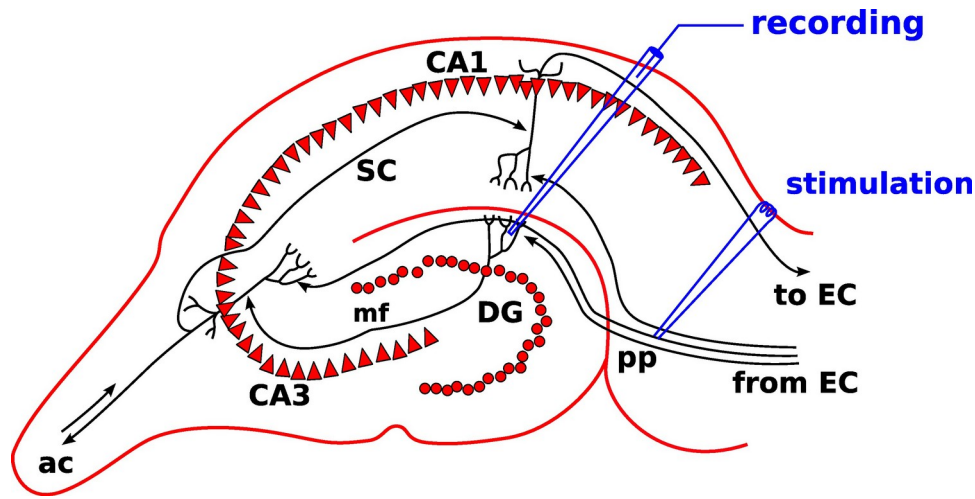

[Bliss and Lømo 1973]

LTD induction: postulate of Stent

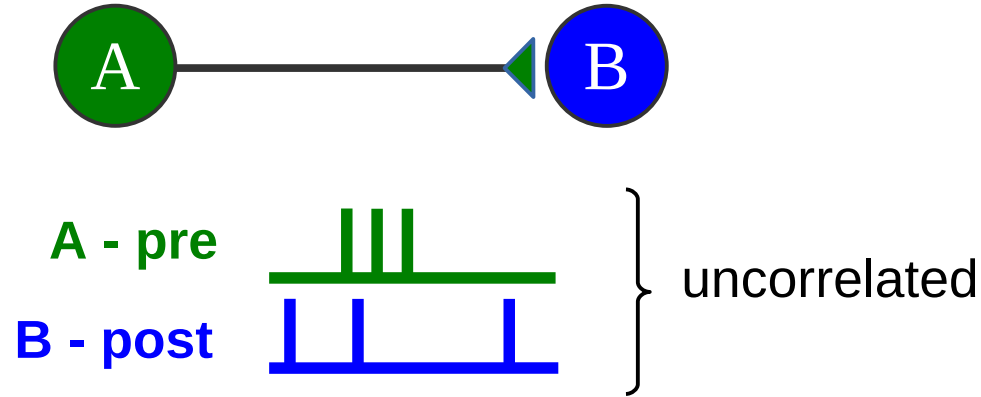

“When the presynaptic axon of cell *A* repeatedly and persistently fails to excite the postsynaptic cell *B* while cell *B* is firing under the influence of other presynaptic axons, metabolic change takes place in one or both cells such that *A*’s efficiency, as one of the cells firing *B*, is *decreased*.”

[G. Stent 1973;
see also Sejnowski 1977, von der Malsburg 1973, Bienenstock et al. 1982]

Plasticity induction: LTD obtained at low frequencies

hippocampus (slices)

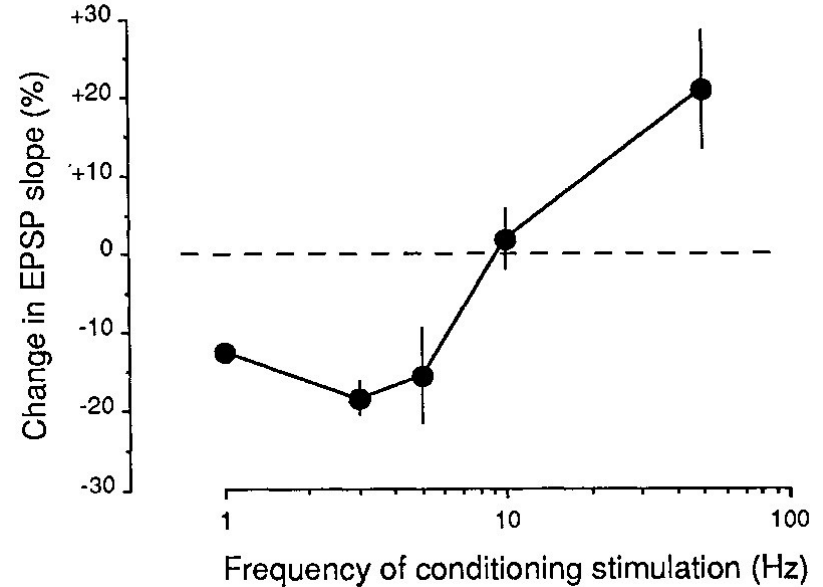
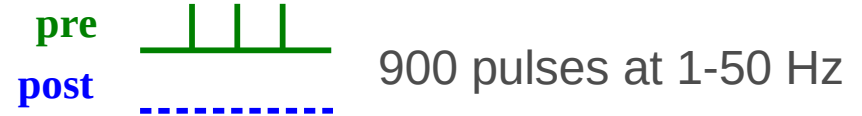
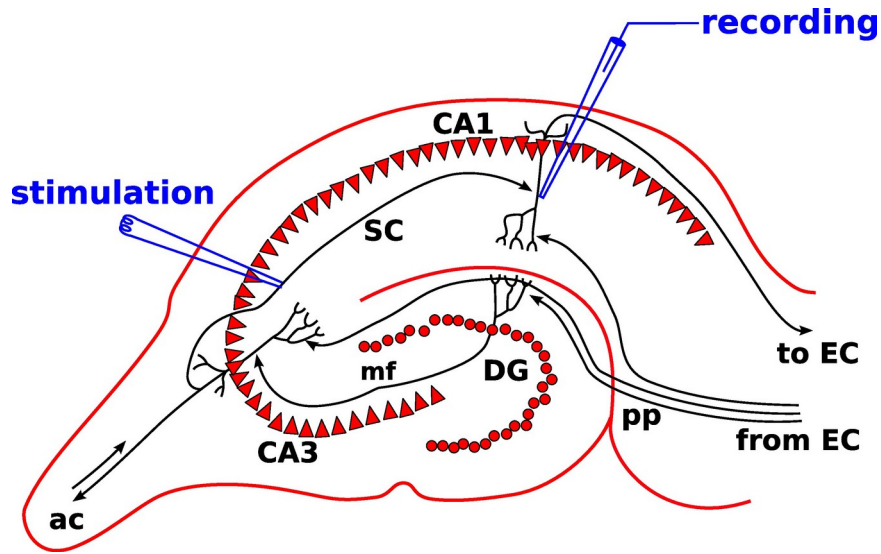

[Dudek and Bear 1992;
Dunwiddie and Lynch 1978]

STDP : plasticity from single spike-pairs

hippocampal cultures

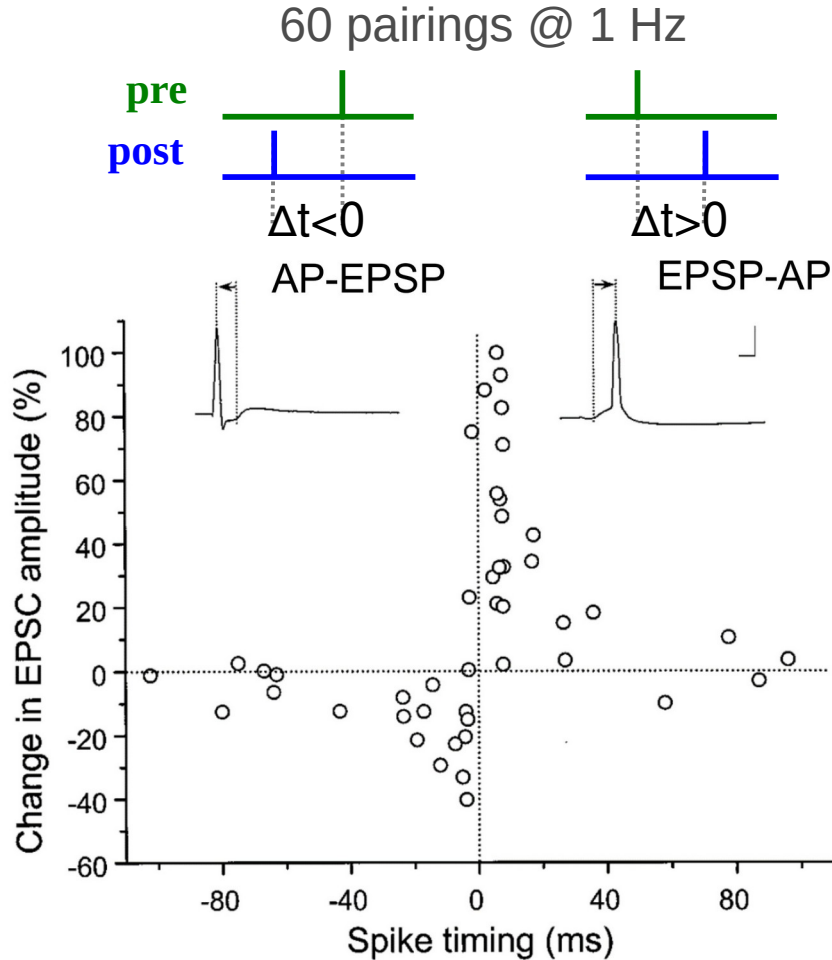
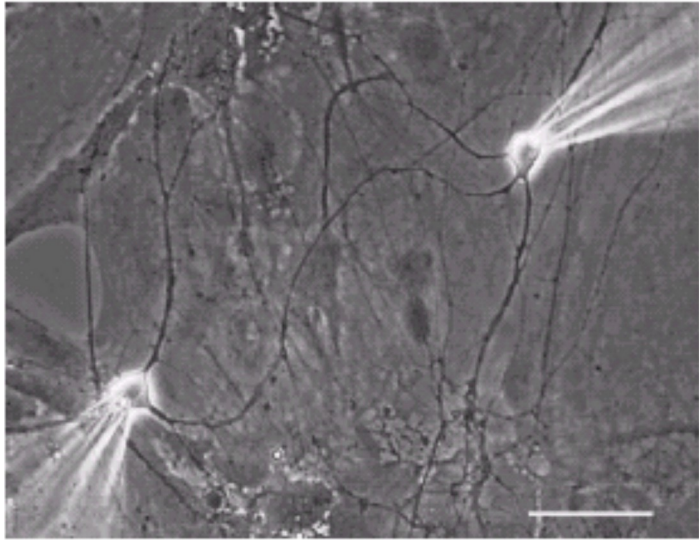

[Bi & Poo, J Neurosci 1998]

[Magee & Johnston 1997;
Zhang et al. 1998;
Markram et al. 1997;
Sjöström et al. 2001;
Feldman 200]

Frequency-dependent plasticity and STDP

frequency-dependent plasticity

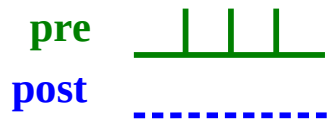

900 pulses at 1-100 Hz

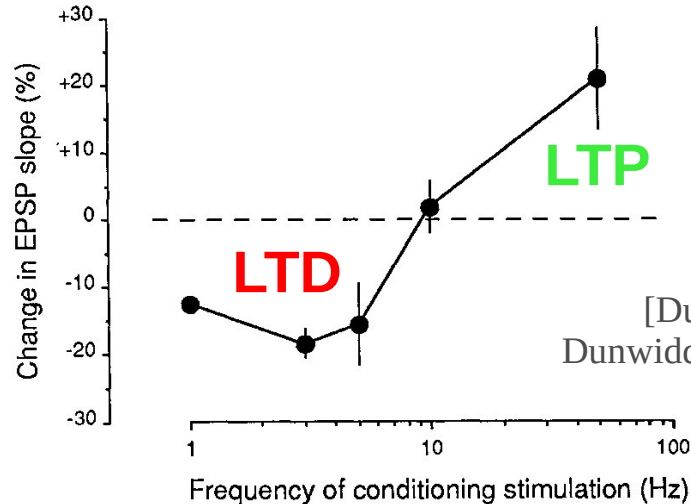

[Dudek and Bear 1992;
Dunwiddie and Lynch 1978]

spike timing-dependent plasticity



60 pairings @ 1 Hz

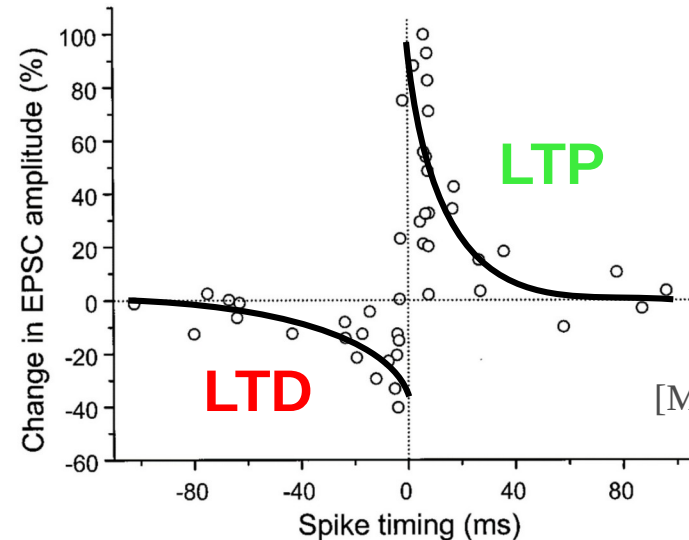

[Markram et al. 1997;
Bi & Poo 1998;
Zhang et al. 1998]

Outline : STDP ... spike-timing dependent plasticity

1. STDP : introduction and history
2. Phenomenology of STDP
3. Induction mechanisms
4. Biophysical models of STDP
5. STDP *in vivo*

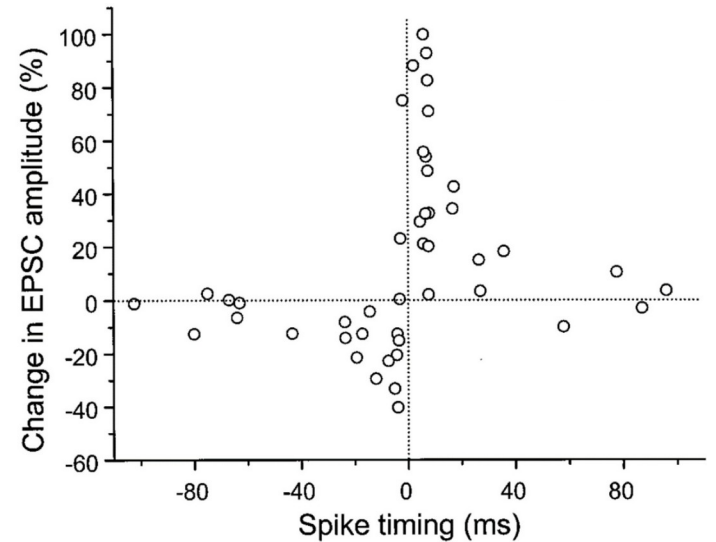

[Bi & Poo 1998]

Number of pairings

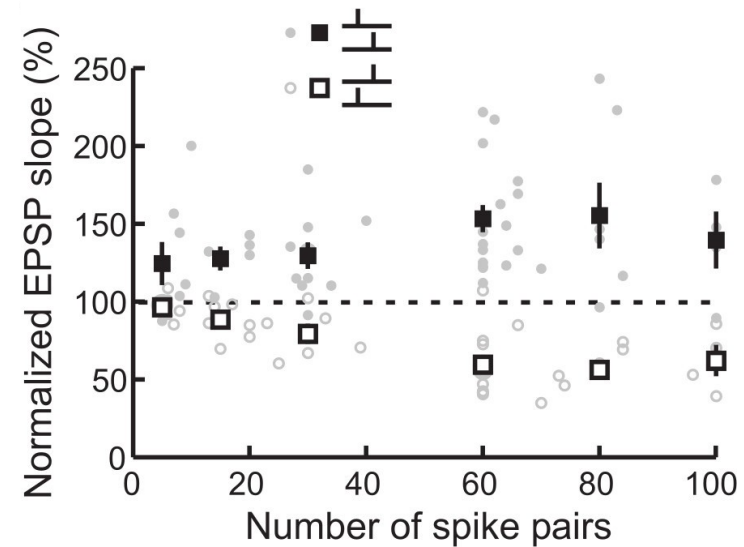
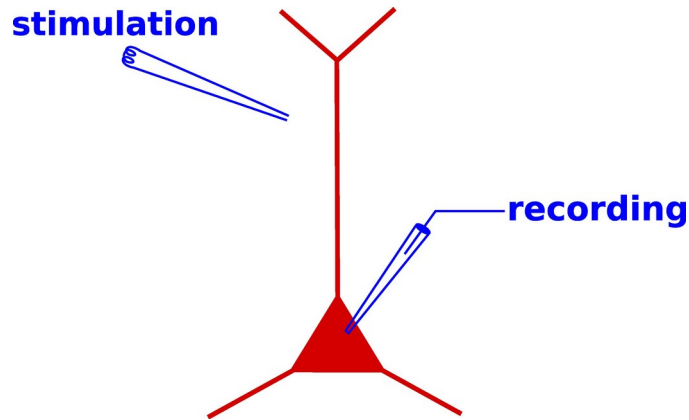

- generally : plasticity induction with spike-pairs requires the *repeated* presentation of the pre-post pair
- LTP induced with a few pairs
- LTD requires the presentation of ~20 stimulation pairs

Role of synaptic inhibition

control
→ **no plasticity**

inhibition blocked
→ **LTP**

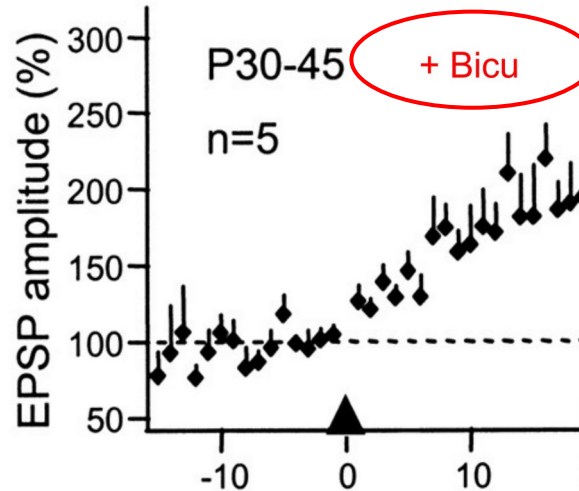
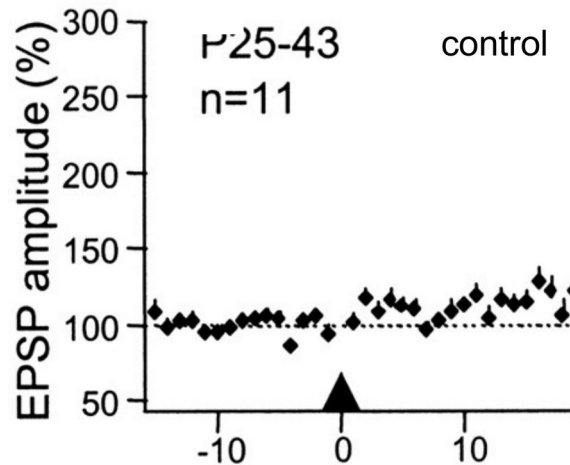

[Mederith et al. *J Neurosci* 2003]

- Attention : inhibition is blocked in many (in particular classical) plasticity studies
- synaptic inhibition can prevent plasticity induction

Bicuculline is a competitive antagonist of GABA_A receptors.

Role of synaptic inhibition

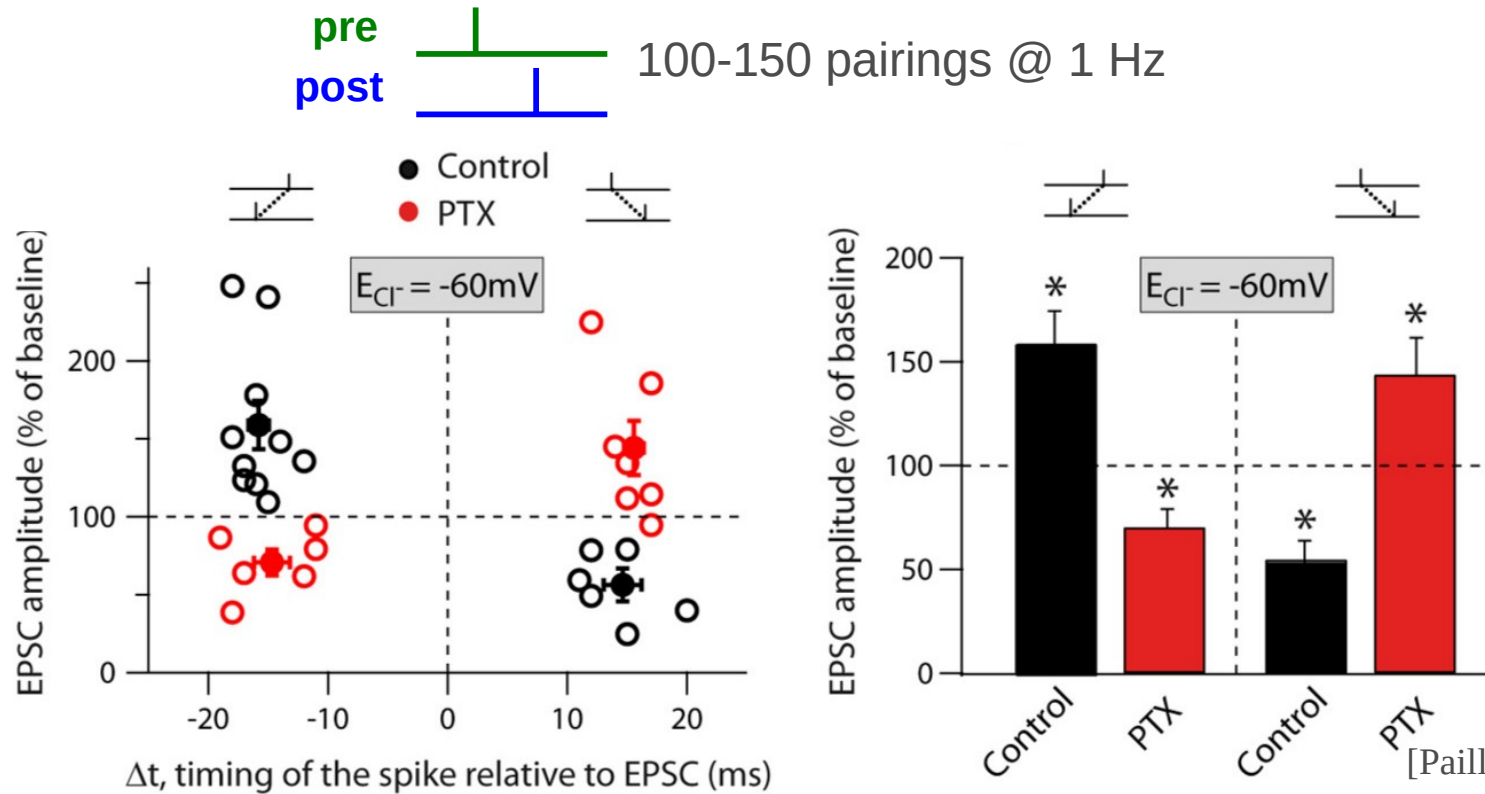

- at the corticostriatal synapse : inhibition inverts the STDP curve

Role of neuromodulation - Dopamine

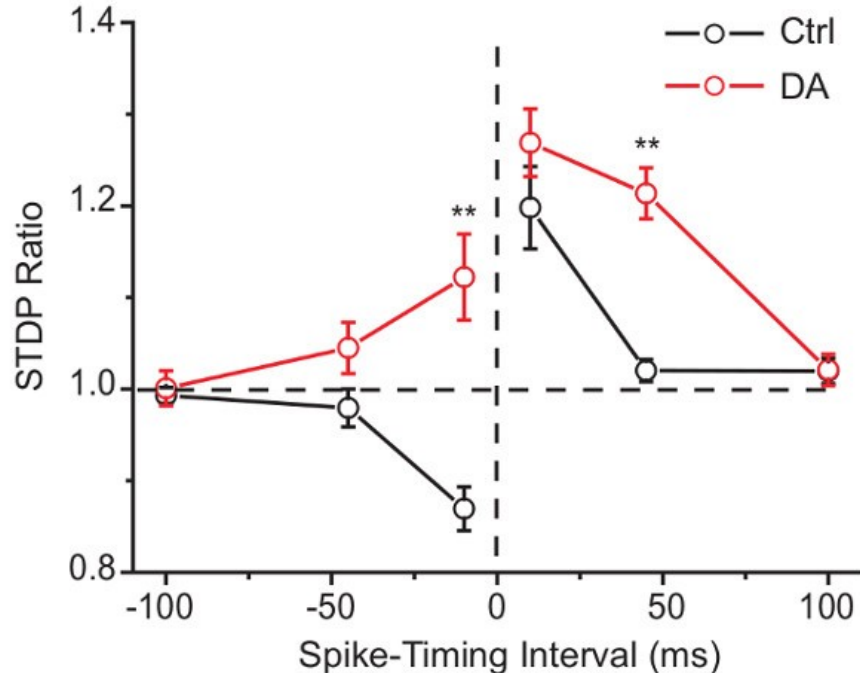
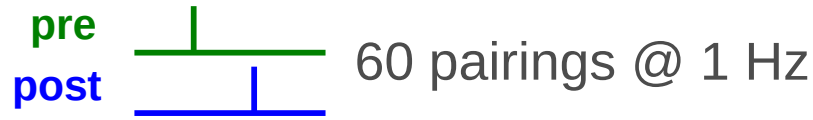

[Zhang et al. *PNAS* 2009]

- many neurotransmitter have been shown to shape synaptic plasticity
- e.g. : dopamine controls sign and magnitude of plasticity

STDP depends on frequency of spike-pairs

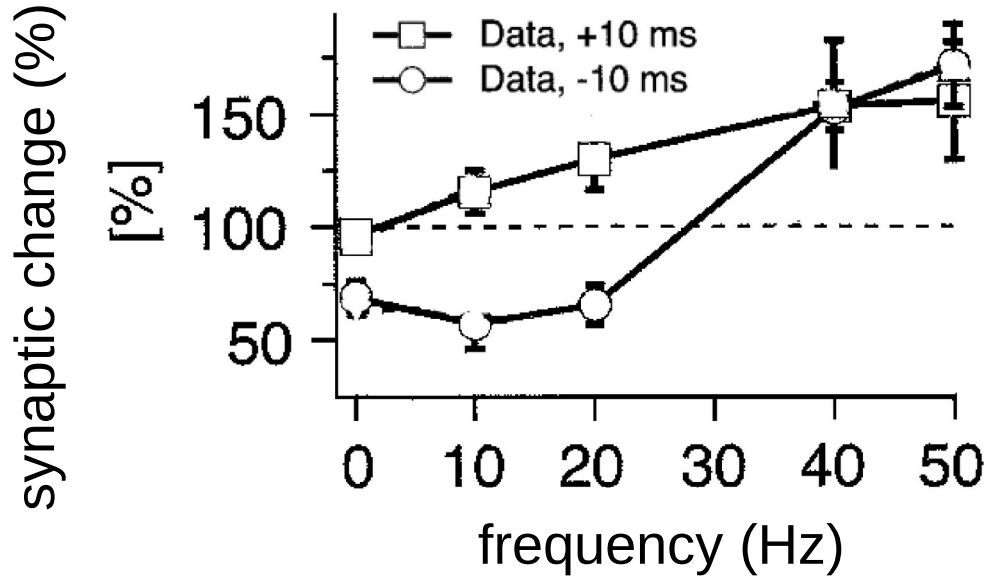
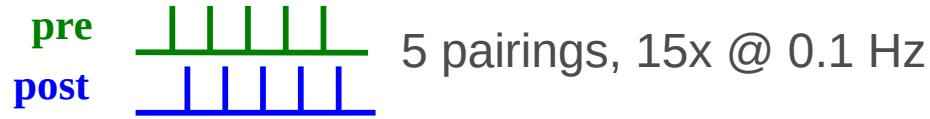

- in the first studies of STDP, spike-pairs were presented at low frequencies
- pre-post pairing induce no plasticity at low and LTP at high frequencies
- post-pre pairings induce LTD at low- and LTP at high frequencies

Non-linearity in STDP induction protocols

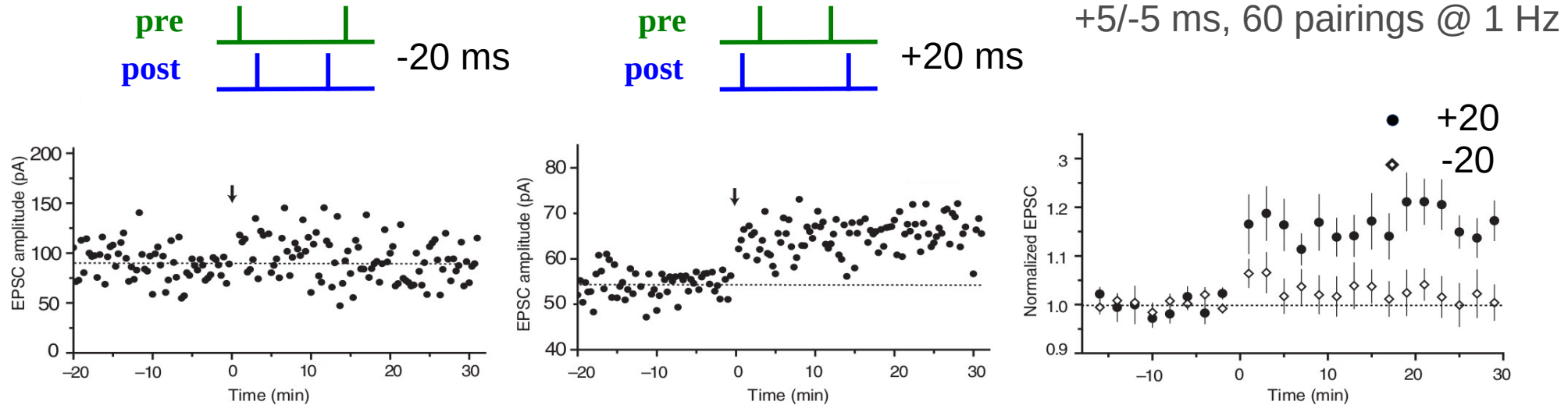

[Wang et al. *Nat Neurosci* 2005]

- order of pre-post, post-pre pairs in quadruplet stimulation determines plasticity outcome
 - pre-post post-pre quadruplet \rightarrow no plasticity
 - post-pre pre-post quadruplet \rightarrow LTP

STDP windows depends on brain structure, synapse type

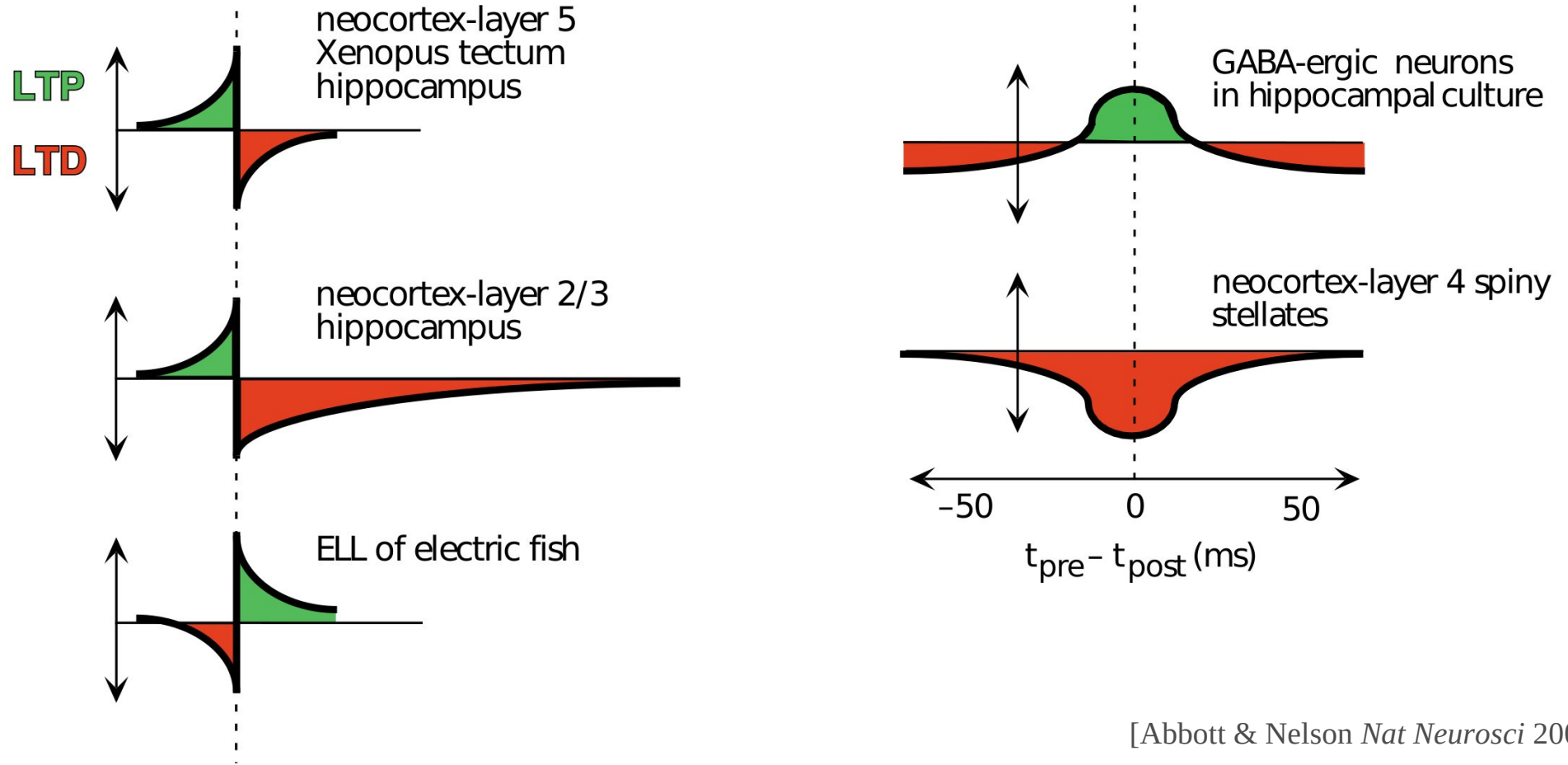

Outline : STDP ... spike-timing dependent plasticity

1. STDP : introduction and history
2. Phenomenology of STDP
3. Induction mechanisms
4. Biophysical models of STDP
5. STDP *in vivo*

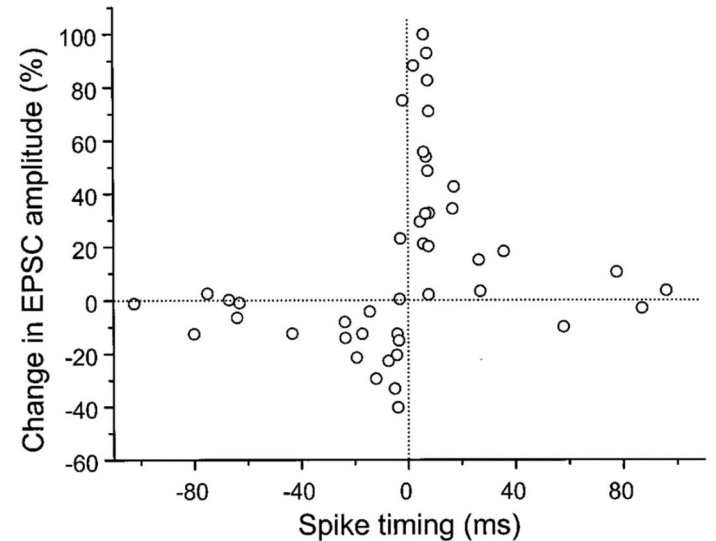

[Bi & Poo 1998]

Backpropagating action potential required for STDP

stimulated synapse

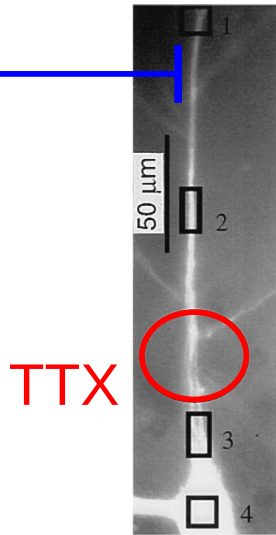

[Ca²⁺] imaging

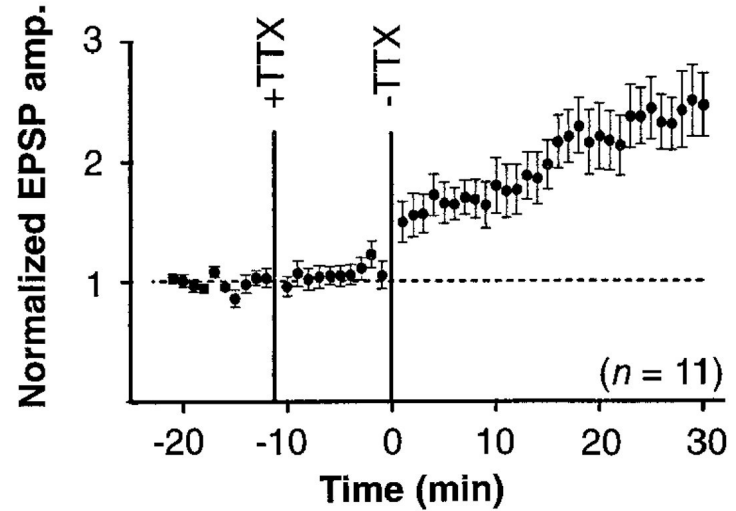
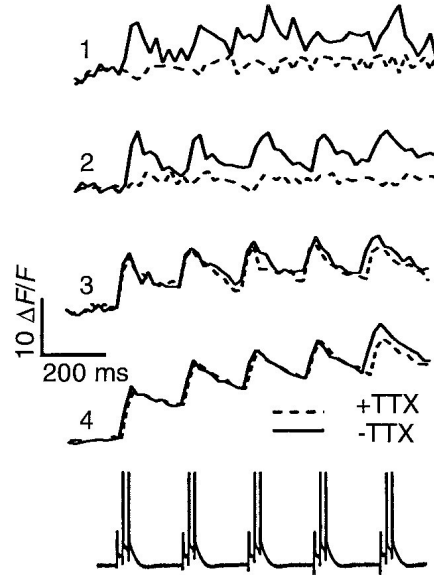

[Magee & Johnston *Science* 1997]

- Backpropagating action potential provides postsynaptic depolarization required for STDP

STDP requires NMDA receptor activation

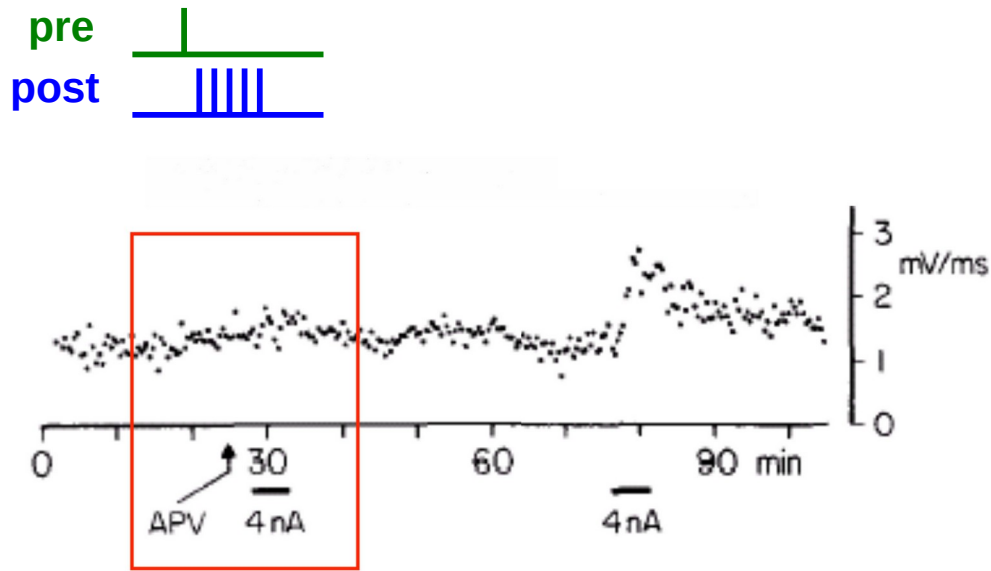

[Gustafsson et al. *J Neurosci* 1987]

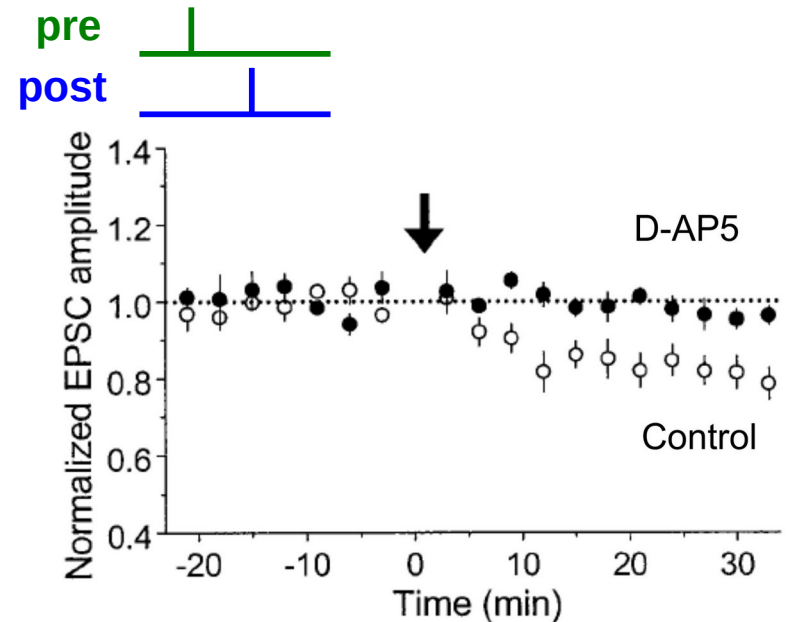

[Bi & Poo *J Neurosci* 1998]

- NMDAR antagonist blocks STDP induction (D-AP5 or APV is a selective NMDA receptor antagonist)

Postsynaptic NMDA receptor

current-voltage relationship

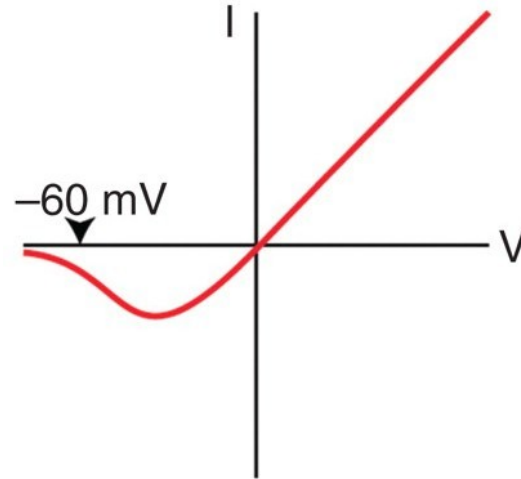
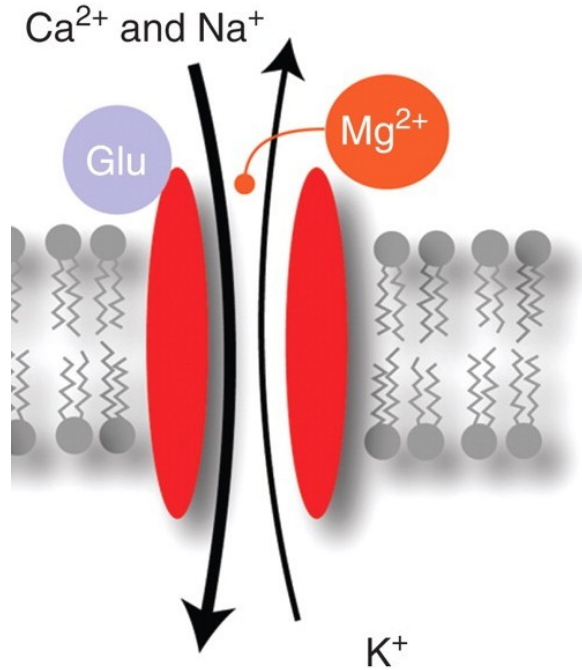

- coincidence detector :
 - presynaptic action potential → glutamate (Glu)
 - postsynaptic depolarization → Mg²⁺ block is expelled
- calcium permeable

Voltage-dependent Ca channels required for LTD

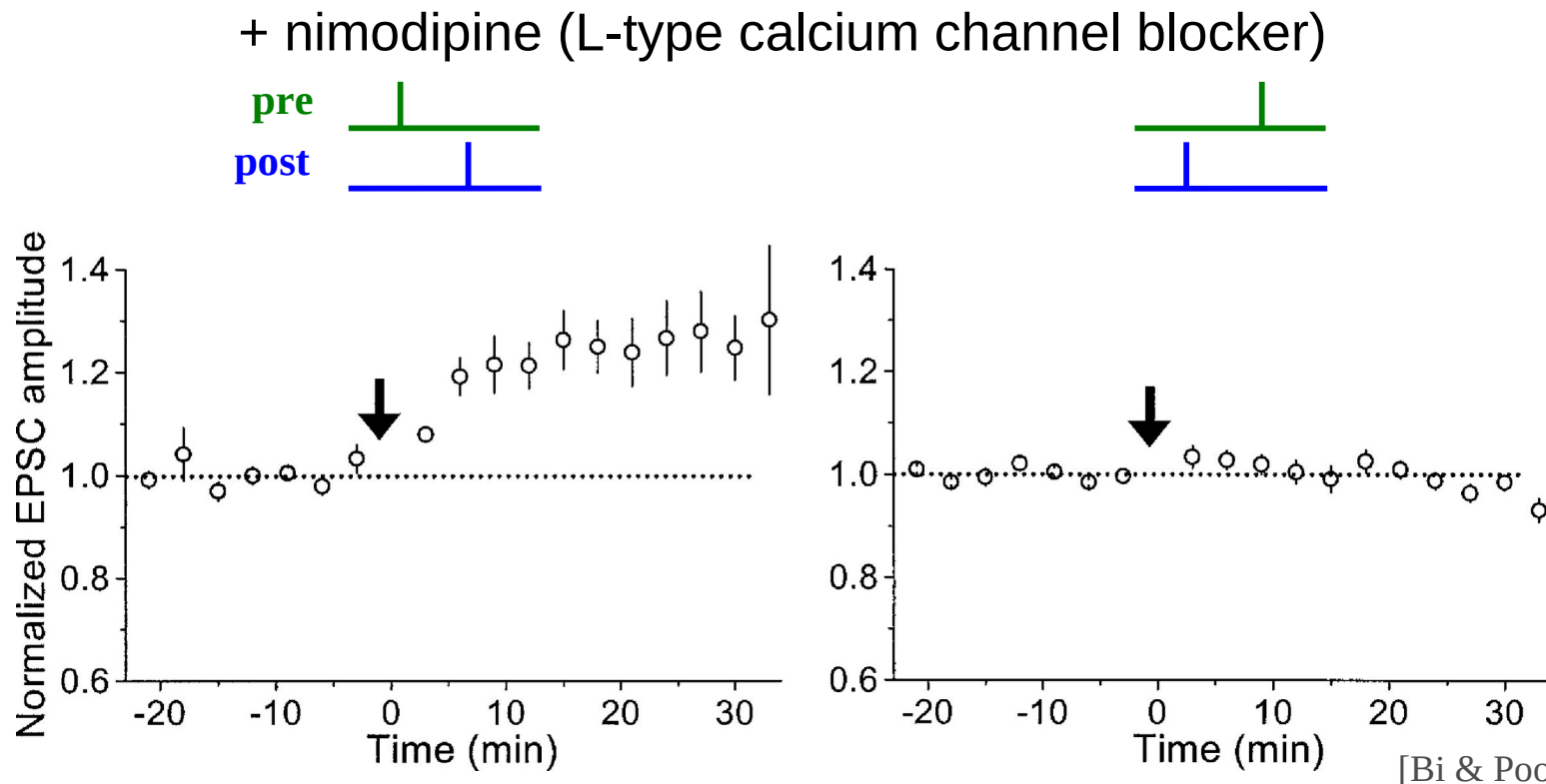

- LTD but not LTP involves the activation of L-type calcium channels

Postsynaptic calcium *required* for plasticity

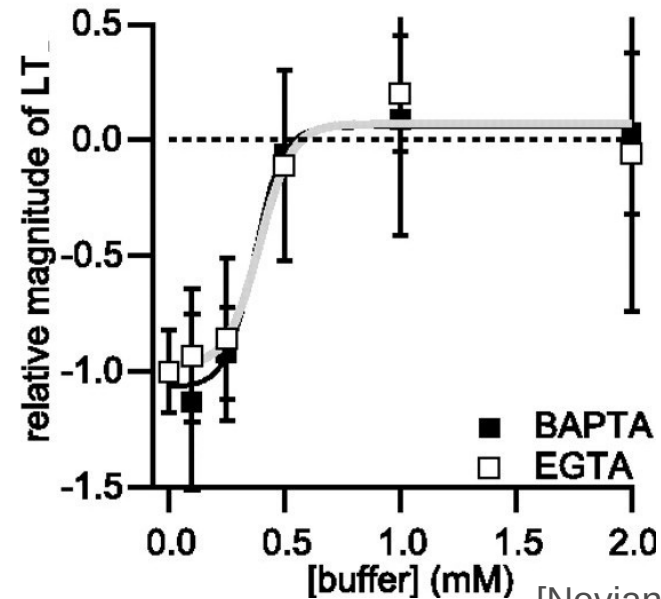
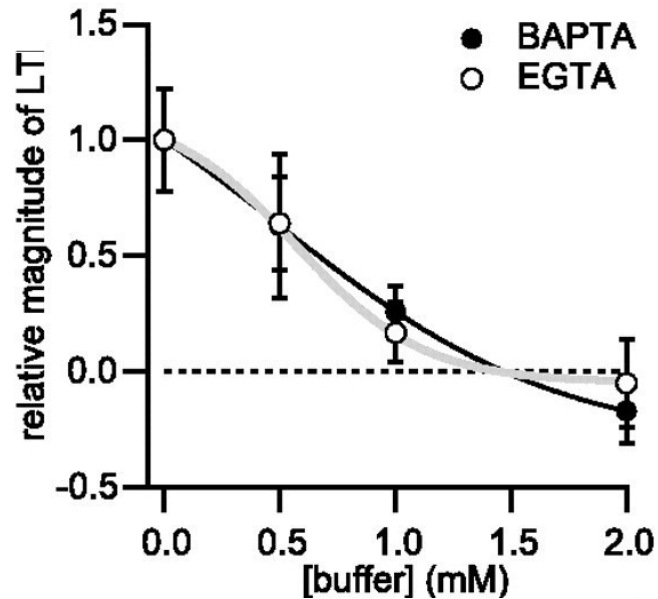
[Nevian & Sakmann *et al.*, 2006]

more buffer -> less free calcium

- LTP/LTD equally sensitive to fast and slow $[Ca^{2+}]$ buffers

Postsynaptic calcium *sufficient* for plasticity

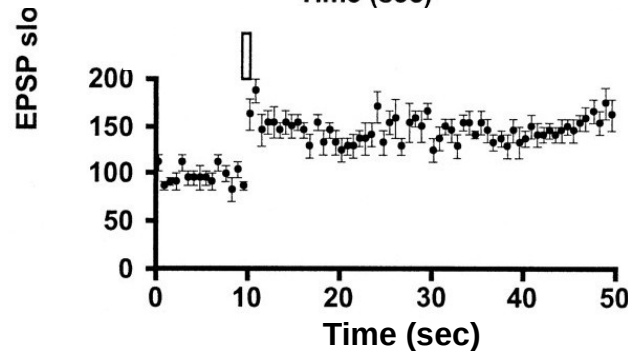
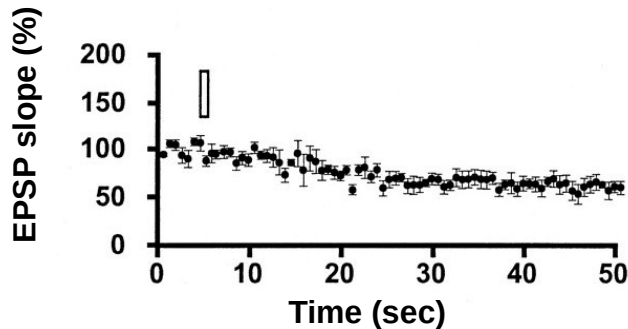
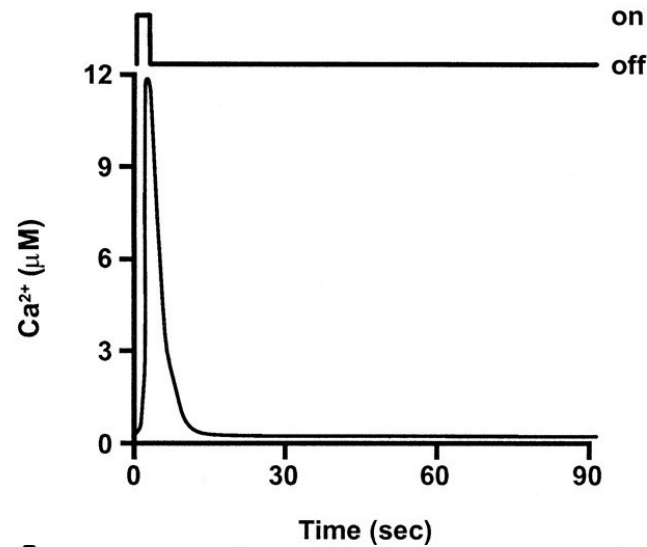
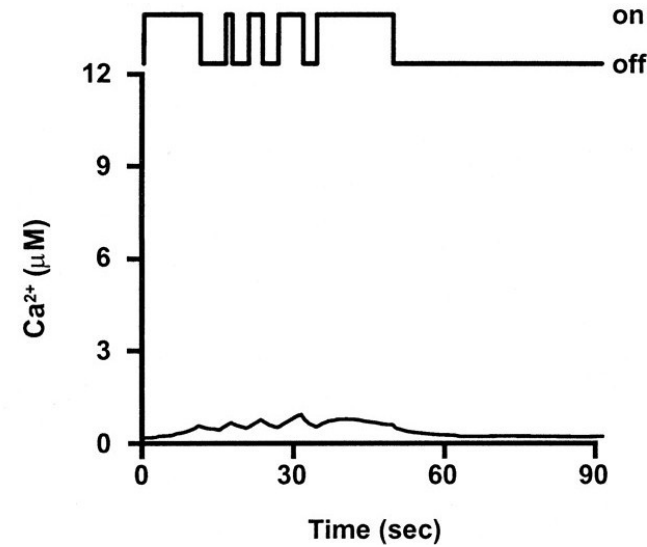

- LTP induced by brief, large amplitude $[Ca^{2+}]$ increases
- prolonged, modest rise in $[Ca^{2+}]$ elicits LTD

[Malenka *et al.* *Science* 1988; Yang *et al.*, *J Neurophysiol* 1999]

Signal pathways downstream of Calcium

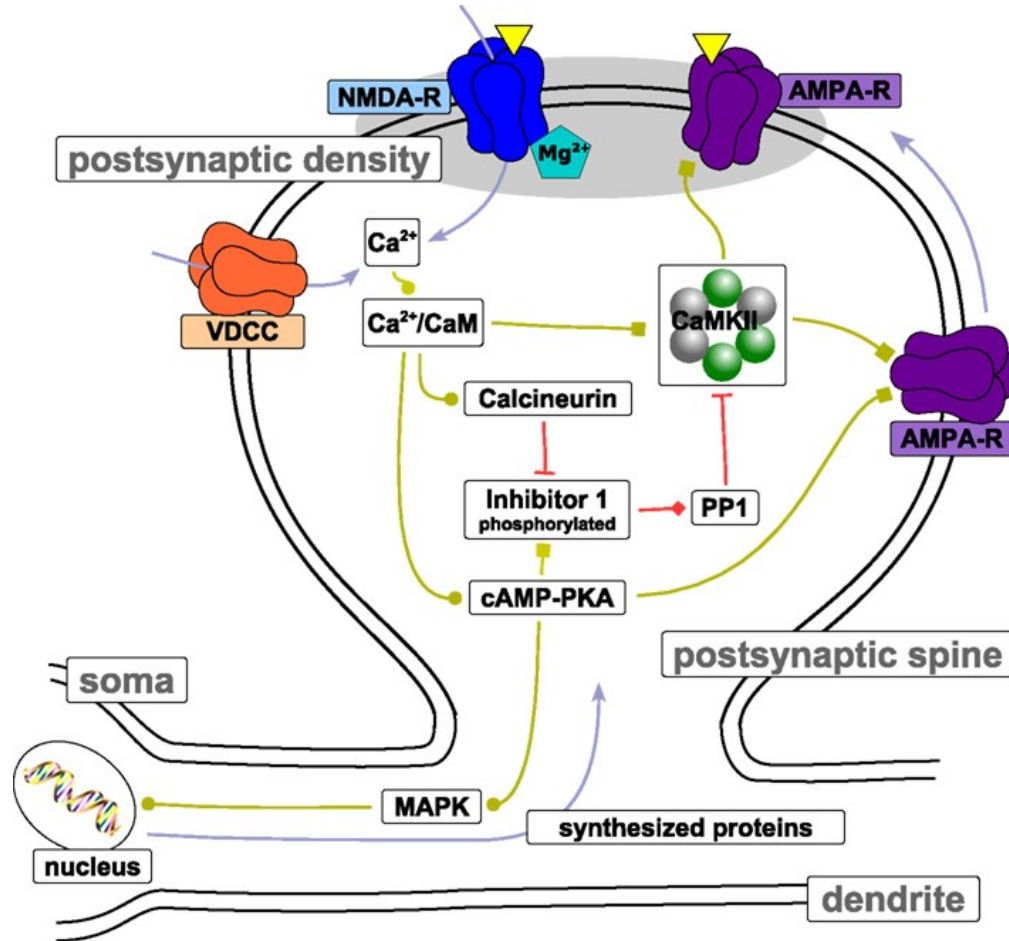

Expression of long-term changes

presynaptic

postsynaptic

neurotransmitter vesicle
number

number of AMPA receptors

probability of vesicle
release

conductance of AMPA
receptors

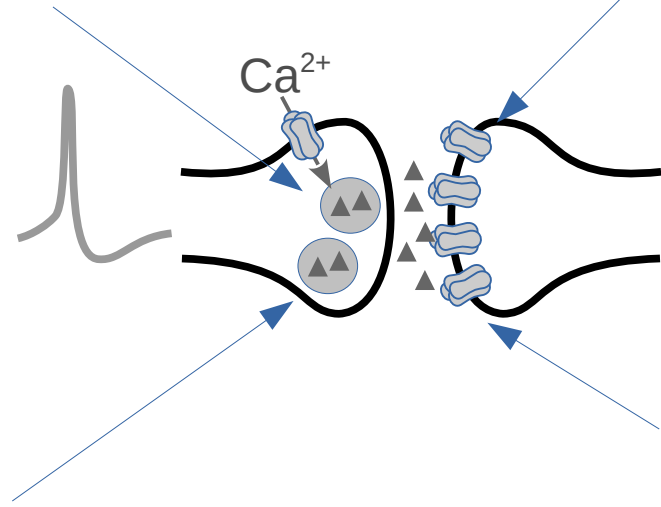

3. Induction mechanisms

Diversity of induction and expression pathways

a NMDAR-dependent LTP

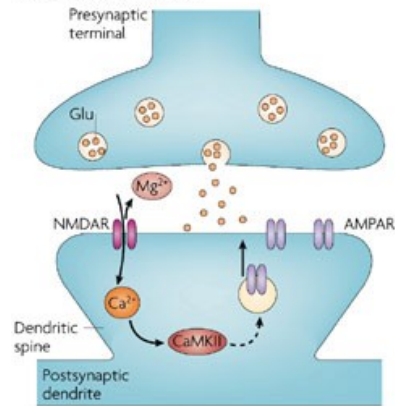

Expression: postsynaptic insertion of AMPARs

b Presynaptic LTP

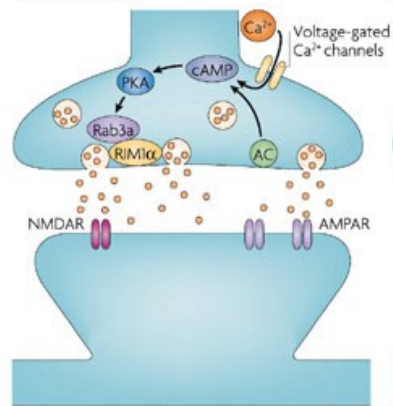

Expression: increased presynaptic neurotransmitter release

c NMDAR-dependent LTD

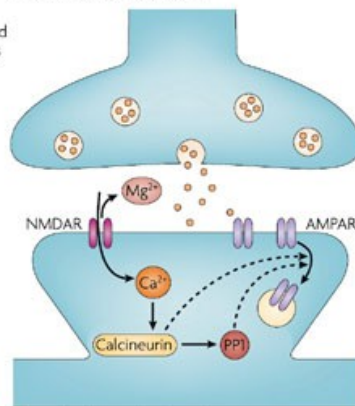

Expression: internalization of postsynaptic AMPARs

d mGluR-dependent LTD

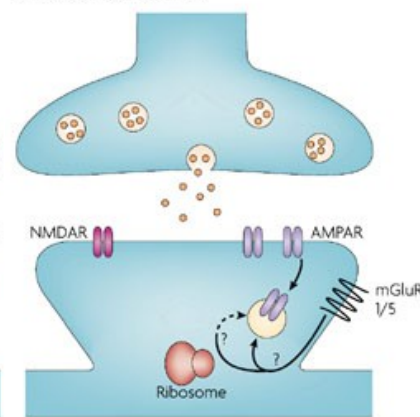

Expression: internalization of postsynaptic AMPARs

e eCB-LTD

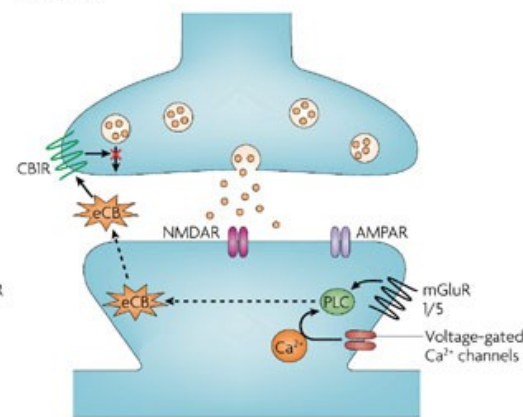

Expression: decreased presynaptic neurotransmitter release

Outline : STDP ... spike-timing dependent plasticity

1. STDP : introduction and history
2. Phenomenology of STDP
3. Induction mechanisms
4. Biophysical models of STDP
5. STDP *in vivo*

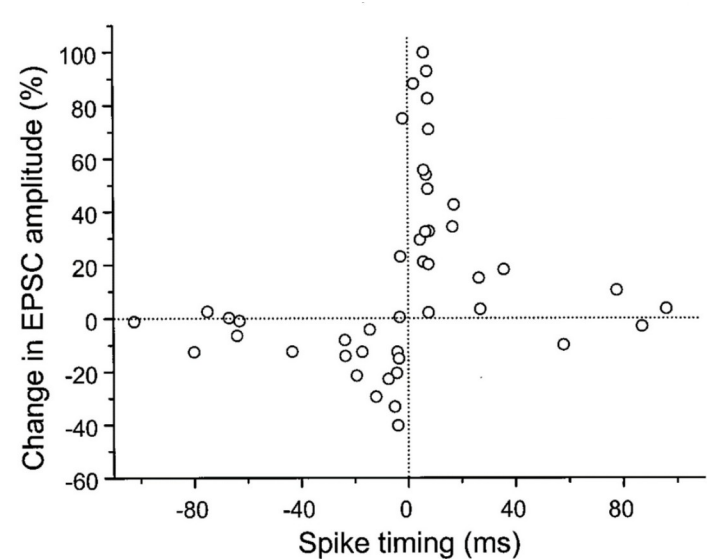

[Bi & Poo 1998]

Modeling : translation from spikes to plasticity results

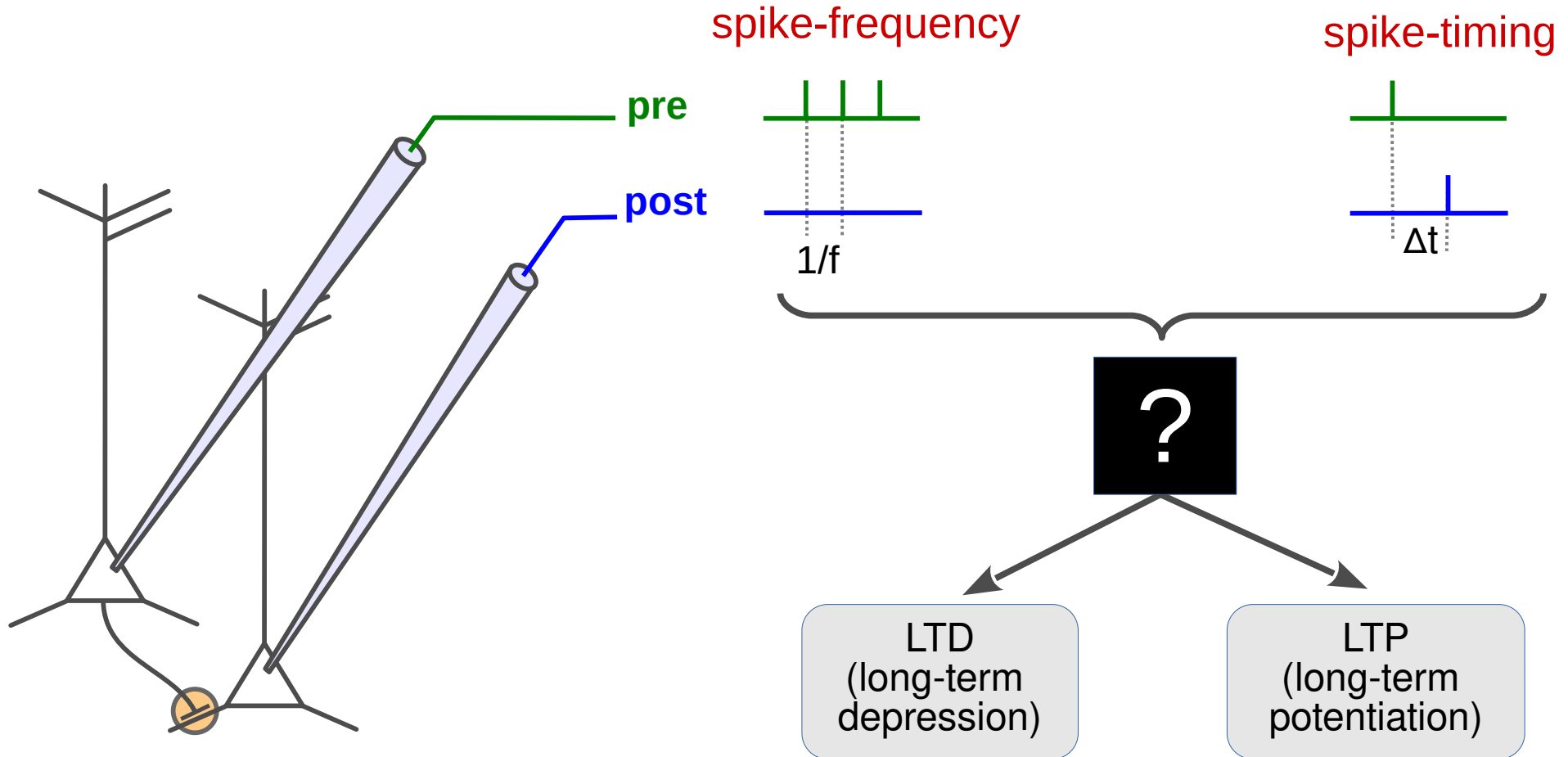

Modeling approaches : phenomenological vs. biophysical

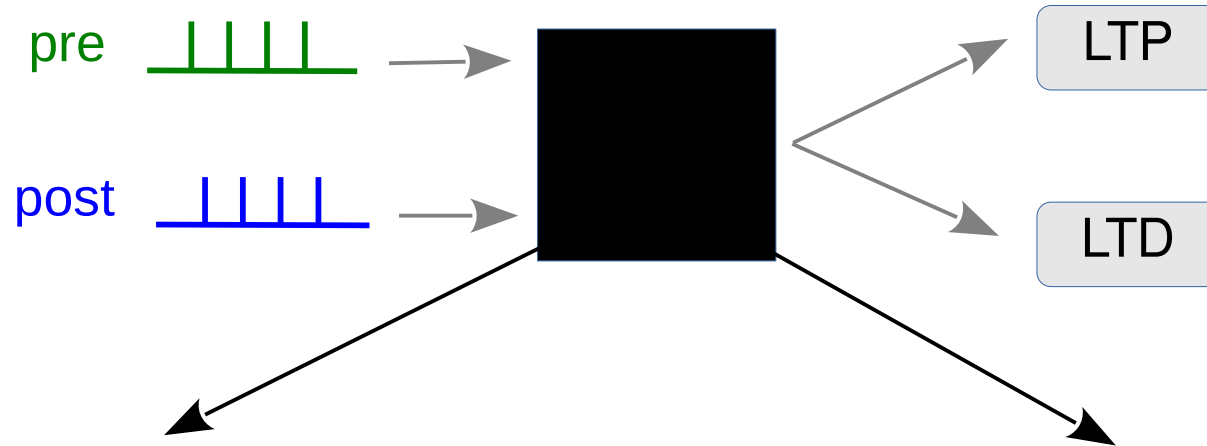

phenomenological models of plasticity

- use pre- and postsynaptic spike times or rate to calculate change in synaptic strength
- conversion can involve arbitrarily complex mathematical models

biophysical models of plasticity

- resolve *parts* of the underlying biological machinery involved in the induction of plasticity
- degree of biological detail varies largely

Modeling approaches : phenomenological vs. biophysical

phenomenological models of LTP/LTD

- **rate-based plasticity models**
[Hebb, 1949; Bienenstock *et al.*, 1982; Oja, 1982]
- **spike-timing based models**
[Gerstner *et al.*, 1996; van Rossum *et al.* 2000; Song, 2000; Pfister & Gerstner, 2006]

biophysical models of LTP/LTD

- **Ca²⁺ – dynamics based models**
[Karmarkar *et al.*, 2002; Shouval *et al.*, 2002; Rubin *et al.*, 2005; Graupner & Brunel 2012]
- **CaMKII kinase-phosphatase system**
[Crick 1984; Lisman, 1985; Okamoto & Ichikawa, 2000; Zhabotinsky, 2000; Graupner & Brunel, 2007; Urakubo *et al.*, 2008]
- **extensive protein networks**
[Bhalla & Iyengar, 1999; Hayer & Bhalla, 2005]
- **local clustering of receptors**
[Shouval, 2005]

“Standard” STDP model

- spike-timing based rules : $\Delta w_{ij} = f(\{t_{ik}\}, \{t_{jk}\})$
- “standard” STDP :

$$f(\{t_{ik}\}, \{t_{jk}\}) = \sum_{k, k'} F(t_{ik} - t_{jk'})$$

$$F(\Delta t) = \begin{cases} A_+ \exp(-\Delta t / \tau_+) & \Delta t > 0 \\ A_- \exp(-\Delta t / \tau_-) & \Delta t < 0 \end{cases}$$

- Variations of the rule :
 - * additive/multiplicative
 - * All-to-all spike pairings / nearest neighbors

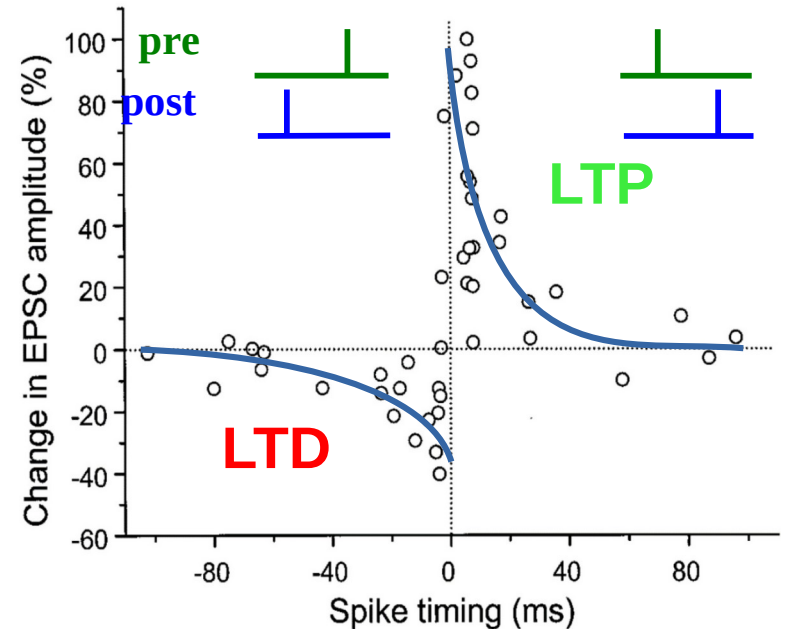

- **Problems** : does not depend on firing rate
does not resolve the non-linearities of plasticity

More recent plasticity models

Triplet-based model

[Pfister & Gerstner, 2006;
Clopath et al., 2010]

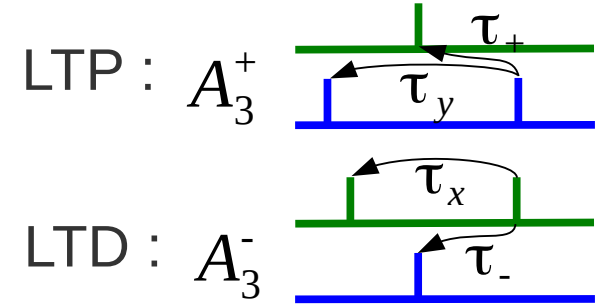
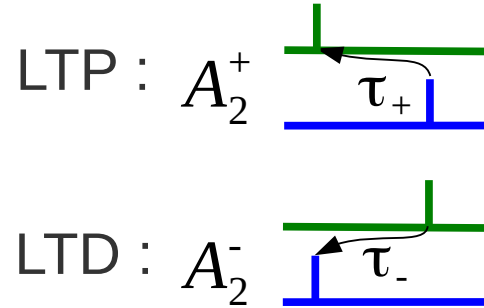

Model based on postsynaptic potential

[Clopath et al., 2010]

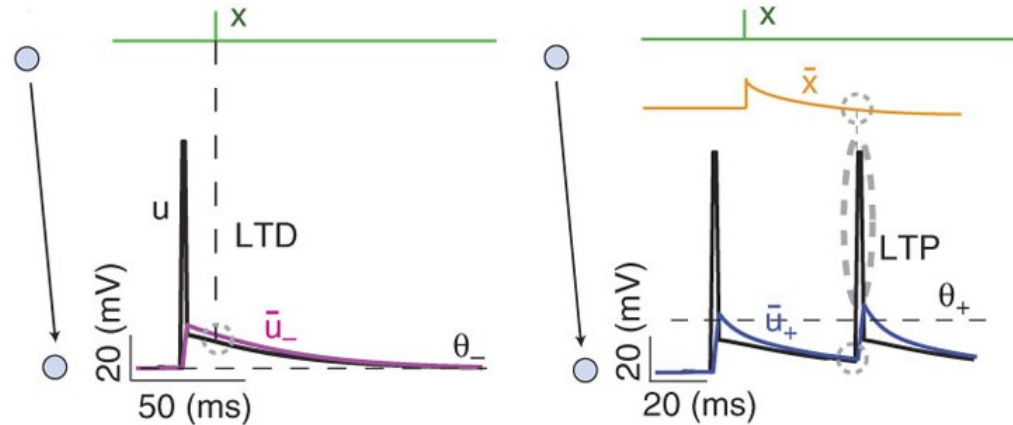

More recent plasticity models

Calcium-based model

[Shouval *et al.* 2002, Graupner & Brunel 2012]

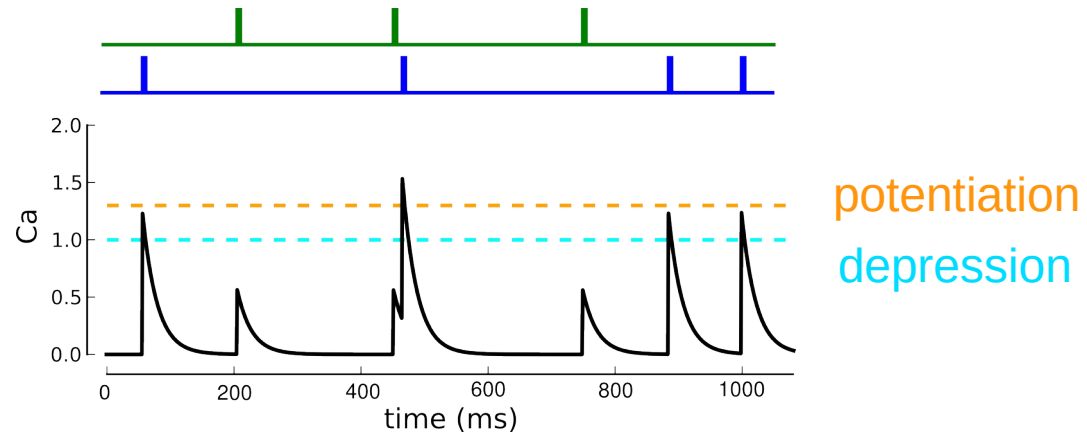

Calcium influx

coincidence detector :

glutamate
presynaptic
activity

+

depolarization
pre- or postsynaptic
activity

depolarization
pre- or postsynaptic
activity

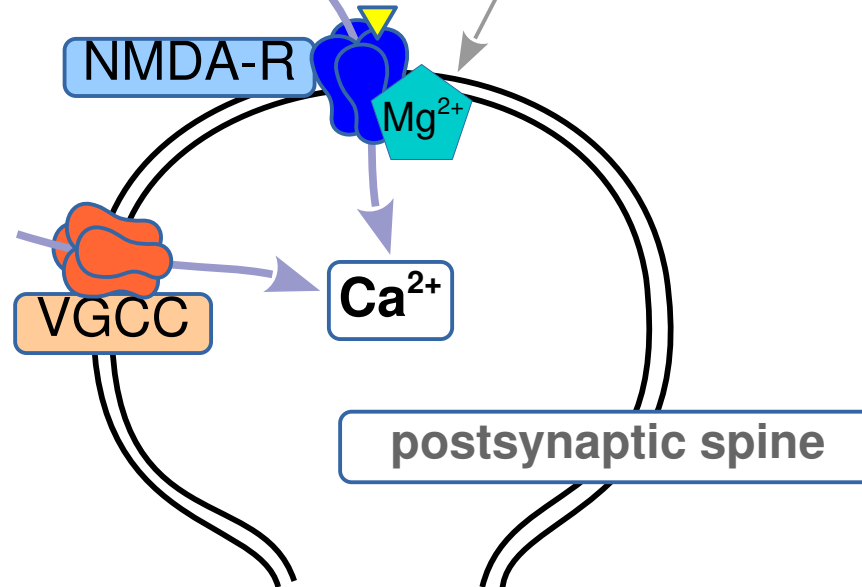

Calcium transients from spike-pair stimulation

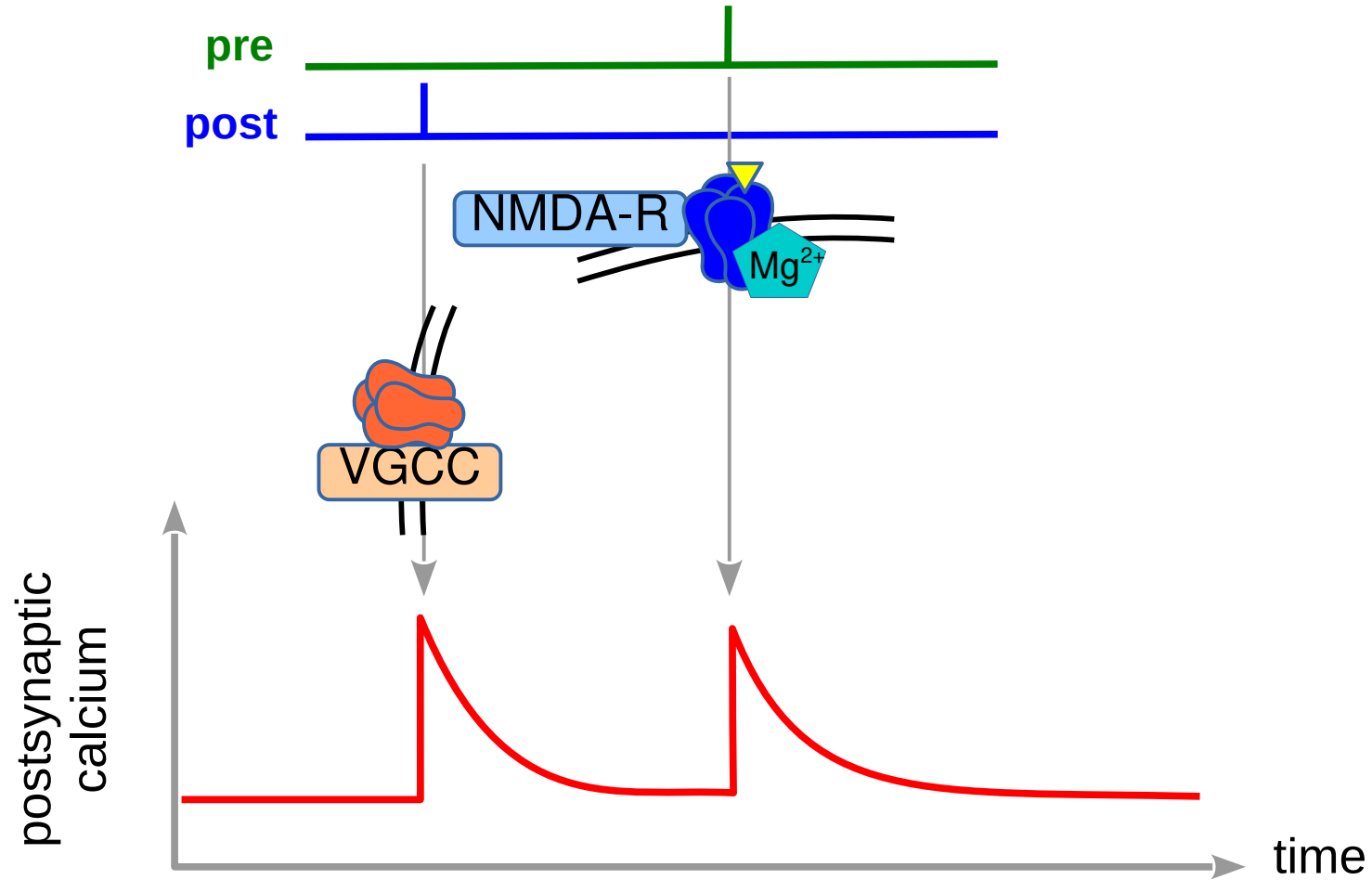

Calcium transients from spike-pair stimulation

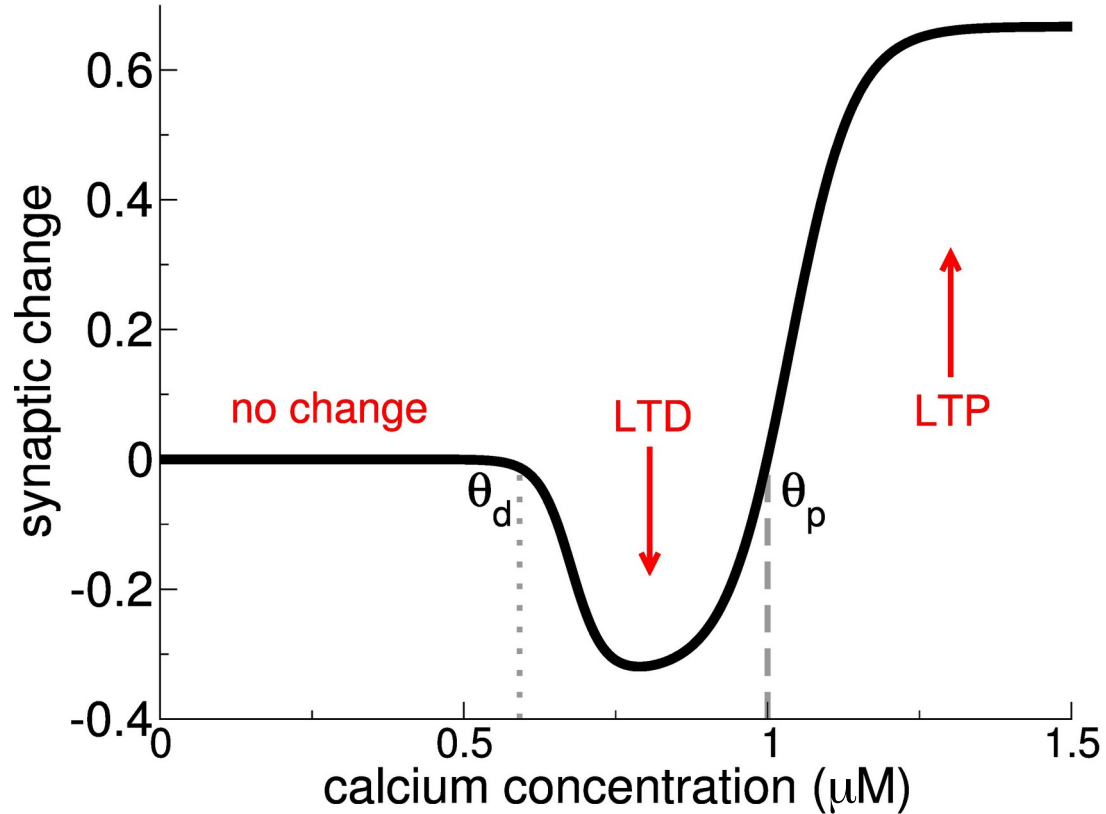

- the calcium control hypothesis posits that the level of postsynaptic calcium concentration controls amplitude and the sign of plasticity

Calcium control hypothesis introduces LTD/LTP thresholds

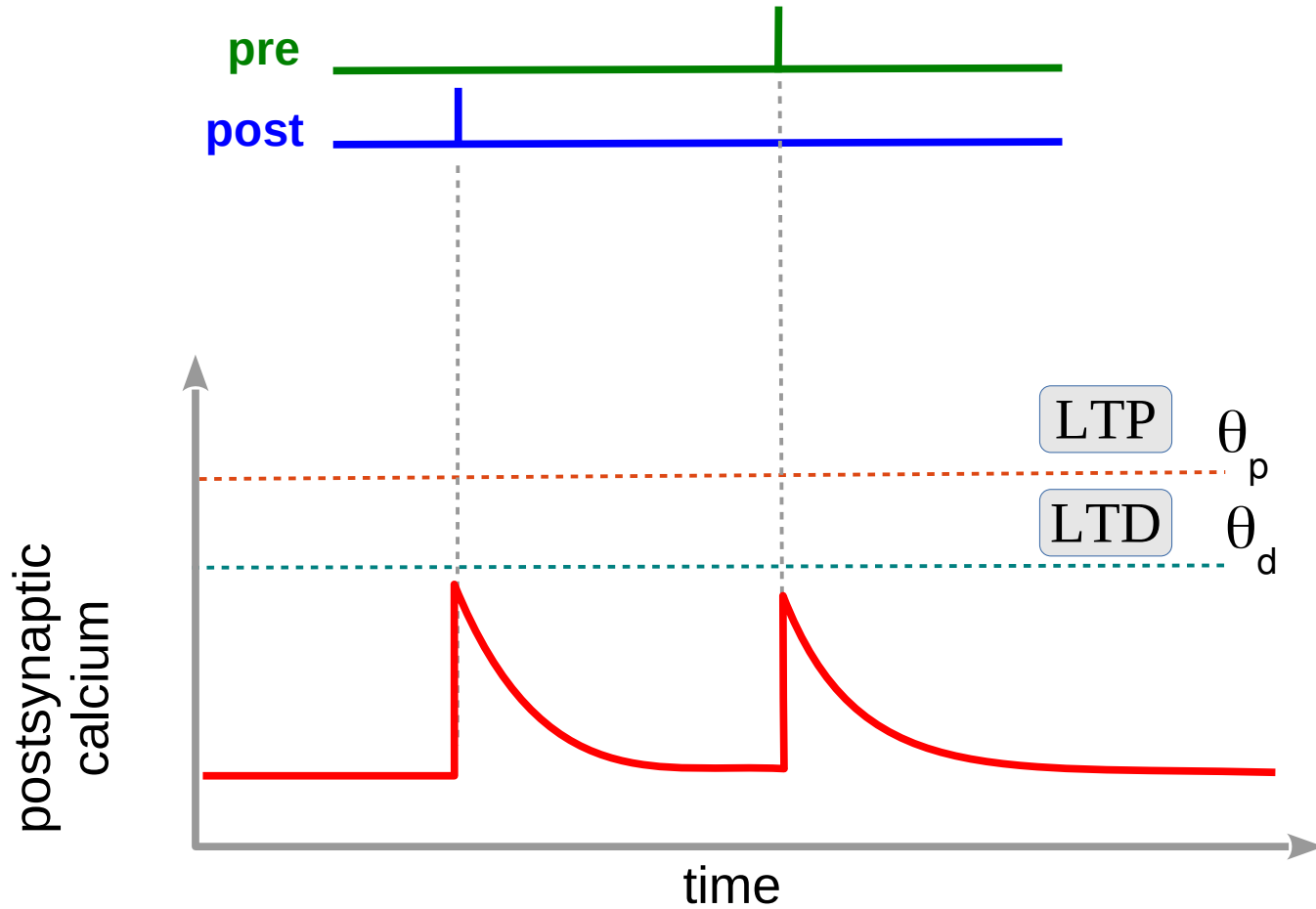

Question : role of calcium in shaping STDP

- I. Can the dynamics of the postsynaptic calcium account for synaptic plasticity induced by spike-pairs ?
- II. To which extent can the STDP phenomenology be explained by calcium ?

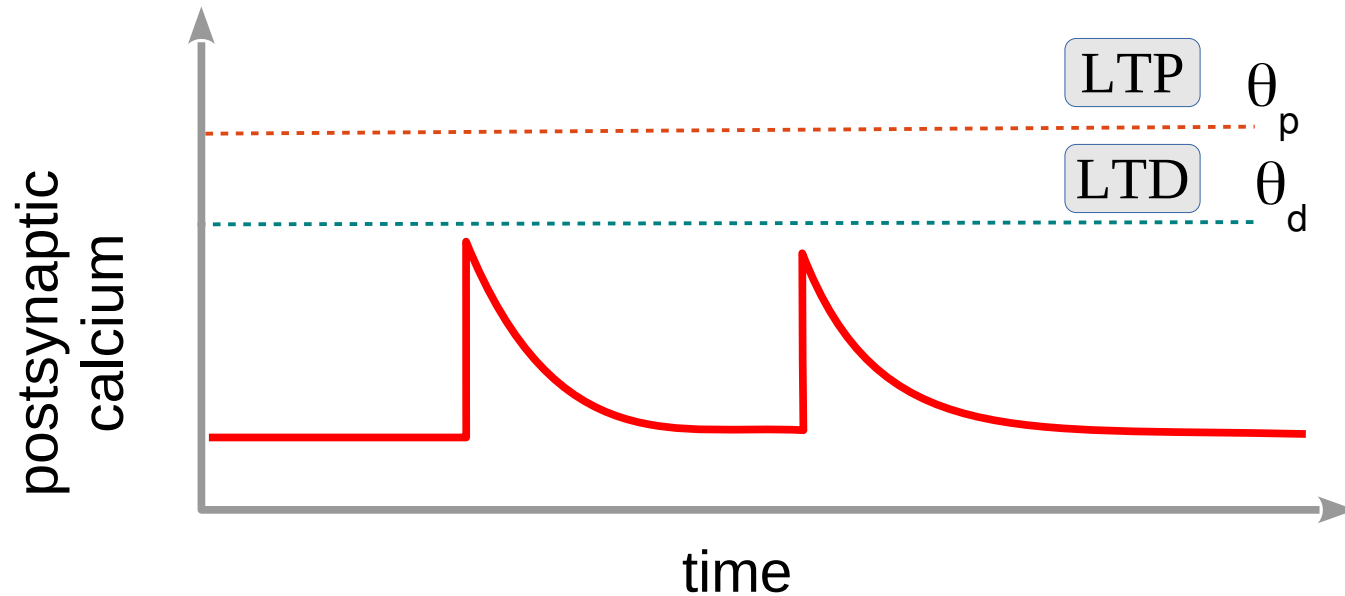

Calcium amplitudes determine shape of STDP curve

simulation I

Calcium amplitudes determine shape of STDP curve

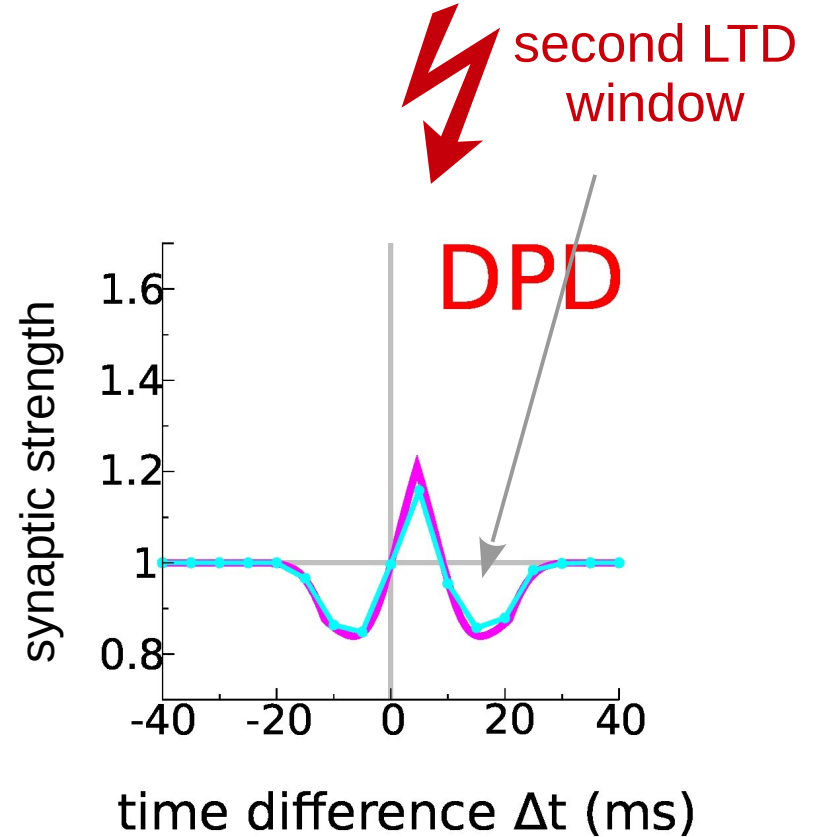
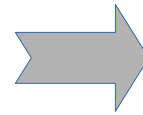
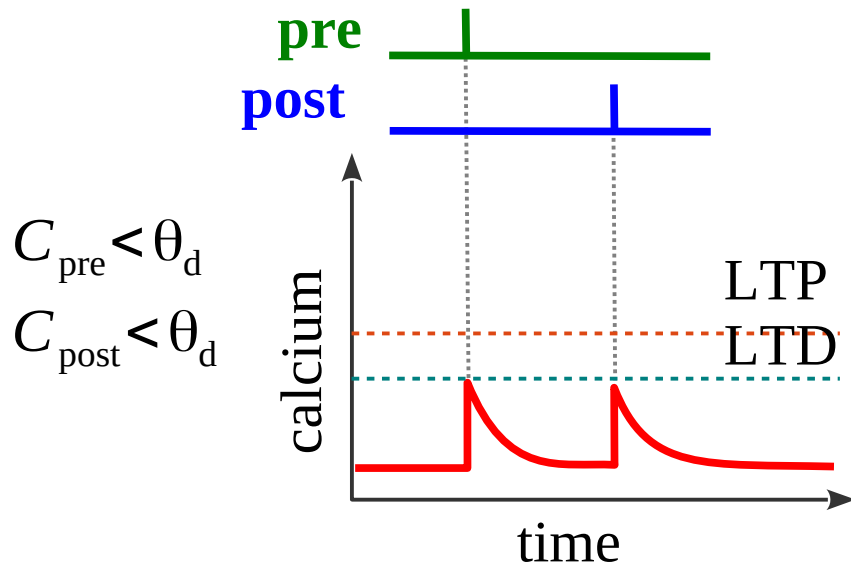

Calcium amplitudes determine shape of STDP curve

simulation II

4. Biophysical models of STDP

Calcium amplitudes determine shape of STDP curve

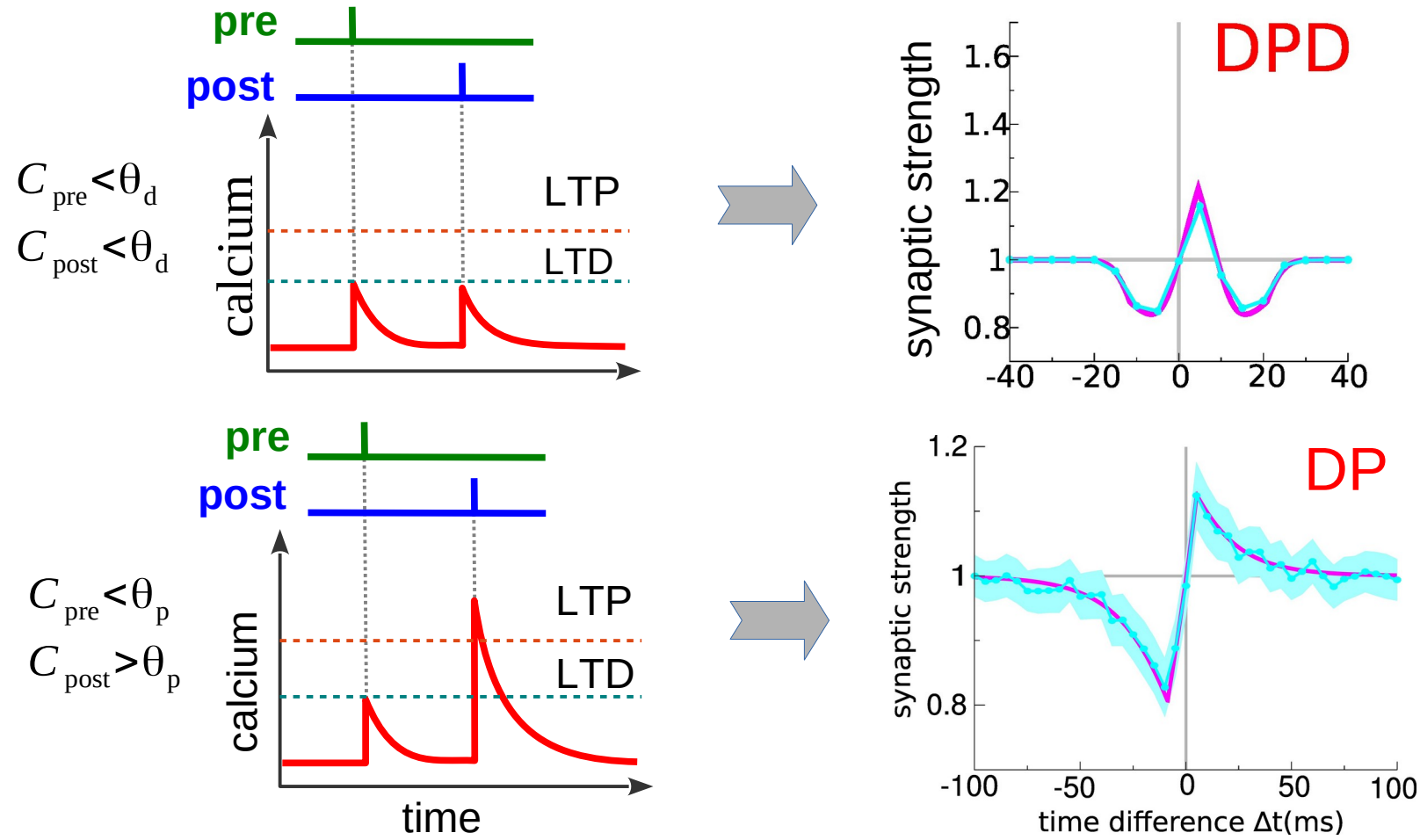

Calcium amplitudes determine shape of STDP curve

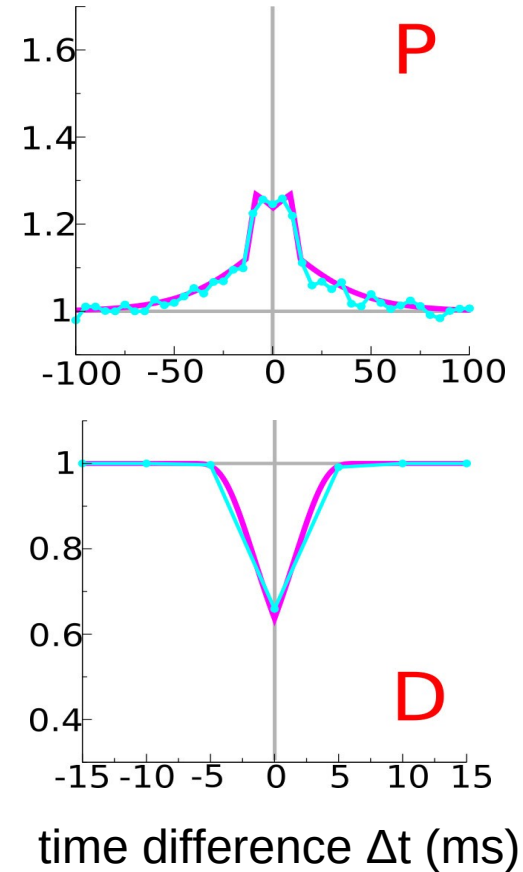
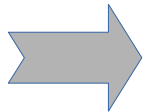
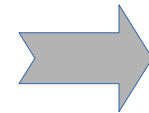
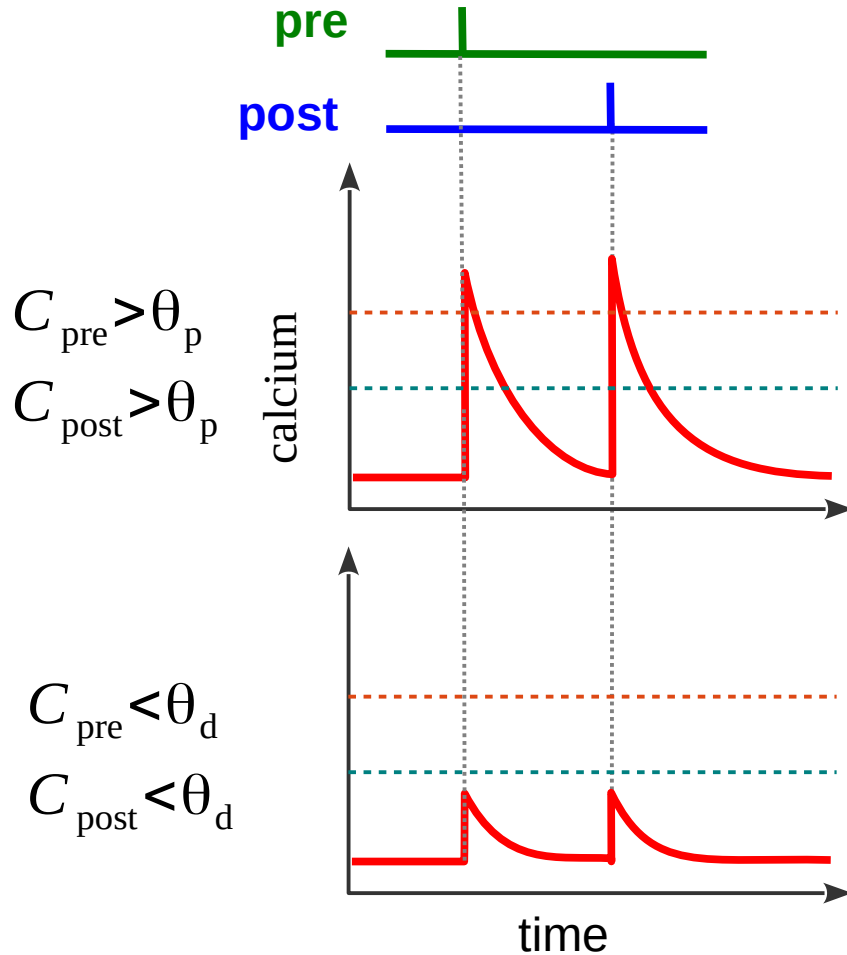

Diversity of STDP curves : spike-pair stimulation

D ... depression , P ... potentiation

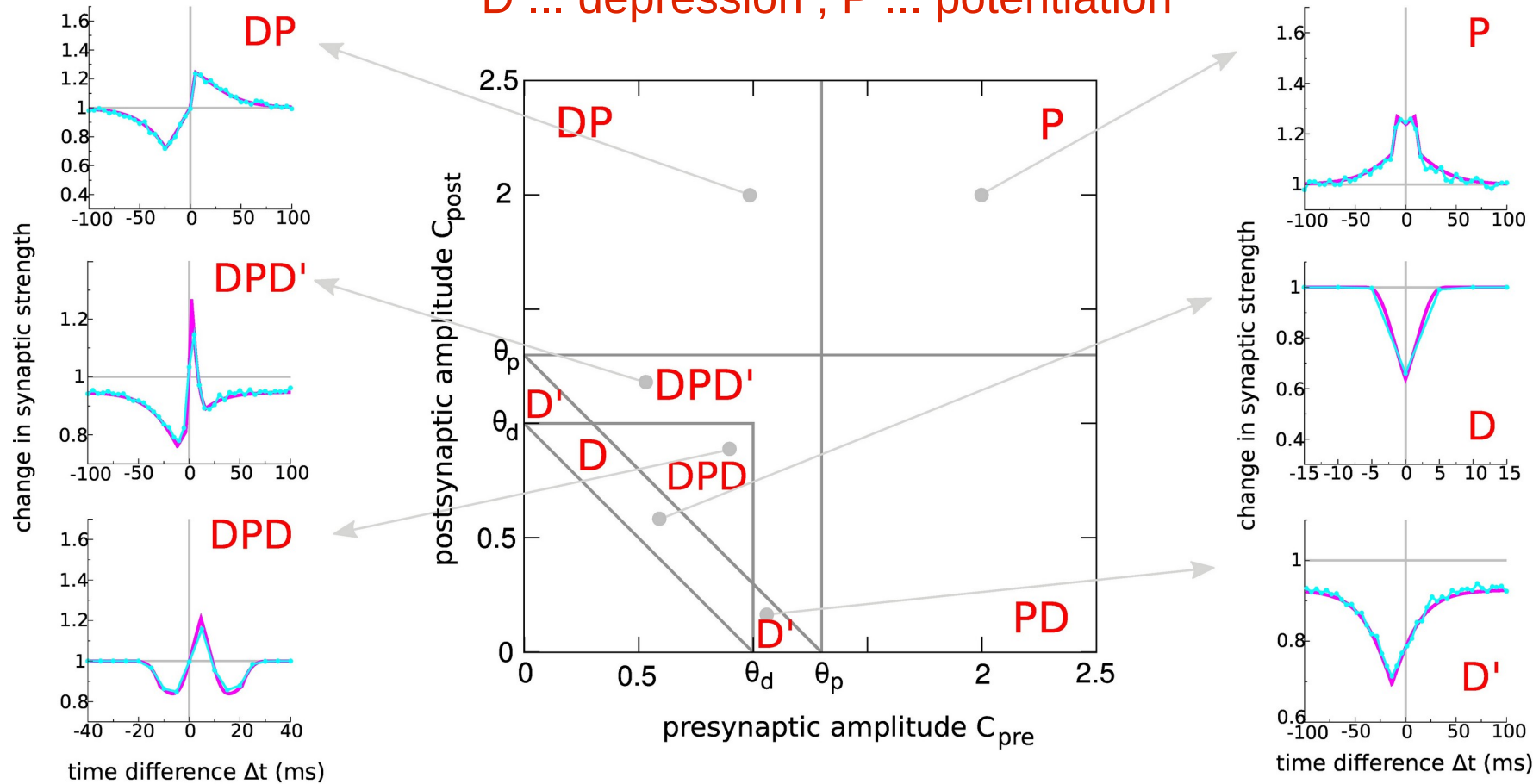

[Graupner & Brunel, *PNAS* 2012]

Diversity of STDP curves : experimental results

- neocortex-layer V
- hippocampus
- Xenopus tectum

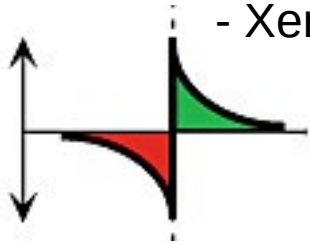

- ELL of electric fish
- corticostriatal synapse

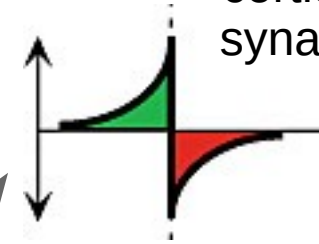

- GABA-ergic neurons in hippocampal cultures

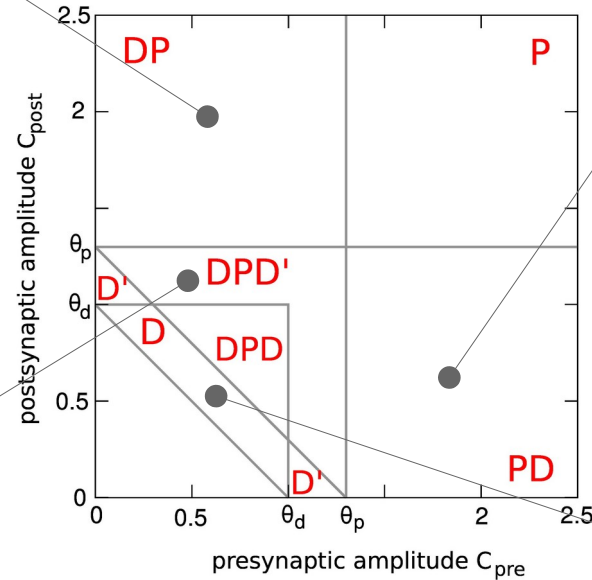
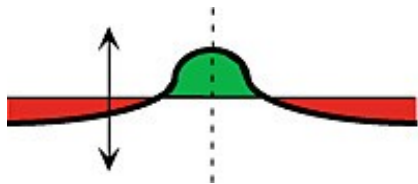

- neocortex-layer IV spiny stellates
- hippocampus

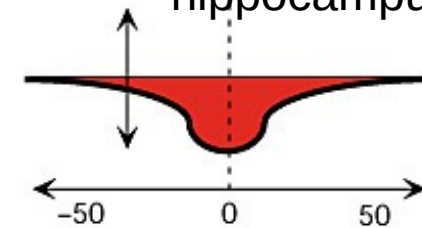

Outline : STDP ... spike-timing dependent plasticity

1. STDP : introduction and history
2. Phenomenology of STDP
3. Induction mechanisms
4. Biophysical models of STDP
5. STDP *in vivo*

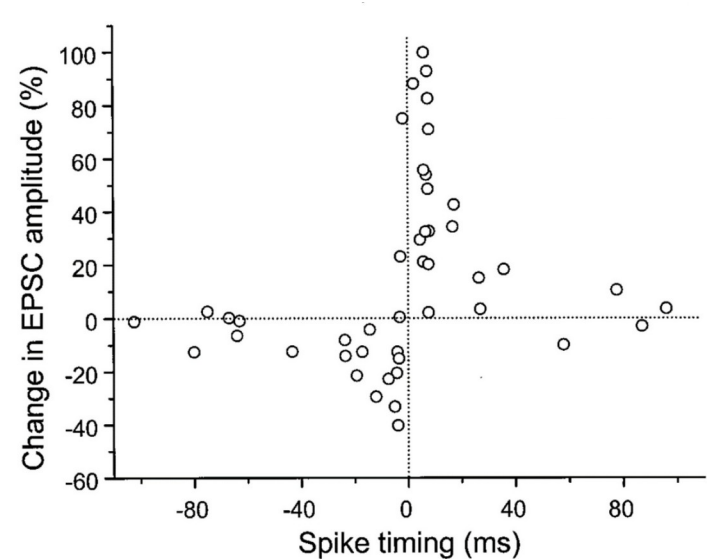

[Bi & Poo 1998]

Firing patterns : Realistic firing is highly irregular

- stimulation protocols used to induce plasticity

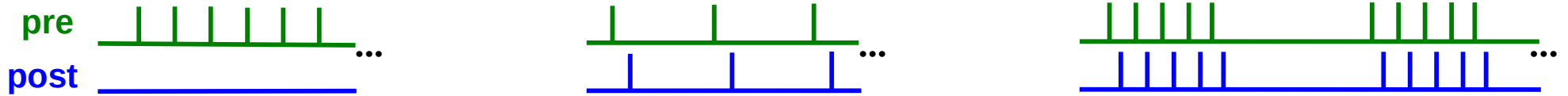

- *in vivo* firing patterns

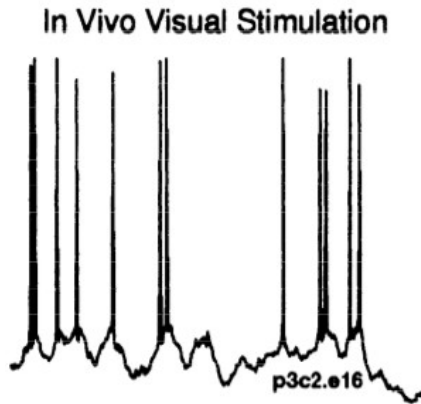

[Holt *et al.*, 1996]

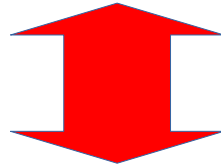

cross-correlation

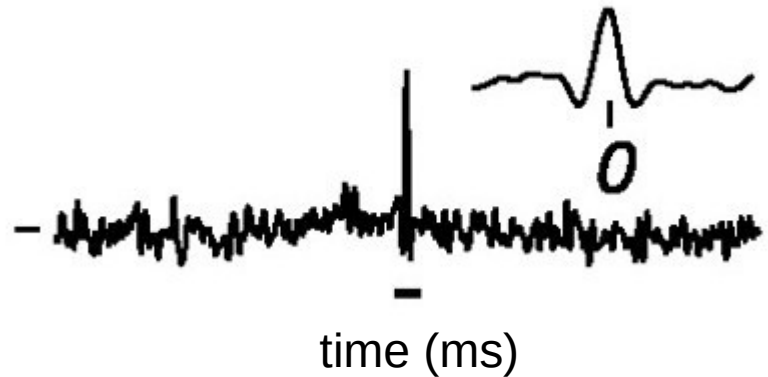

[Kohn and Smith, 2005]

Regular vs. irregular spike-pairs

regular spike-pairs

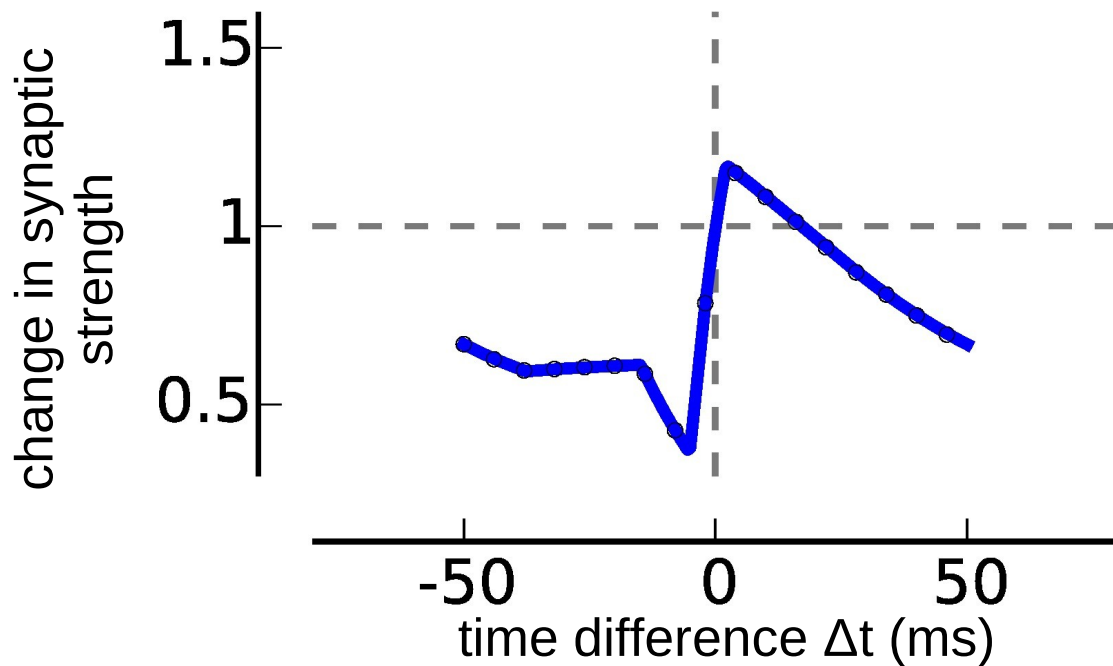
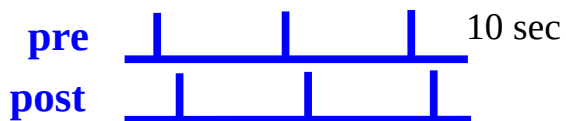

$$\nu_{\text{pre}} = \nu_{\text{post}} = 10 \text{ Hz}$$

Regular vs. irregular spike-pairs

regular spike-pairs

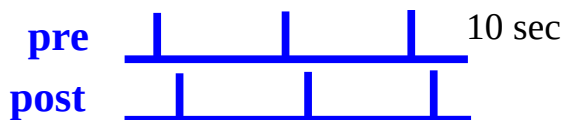

Poisson distributed spike-pairs

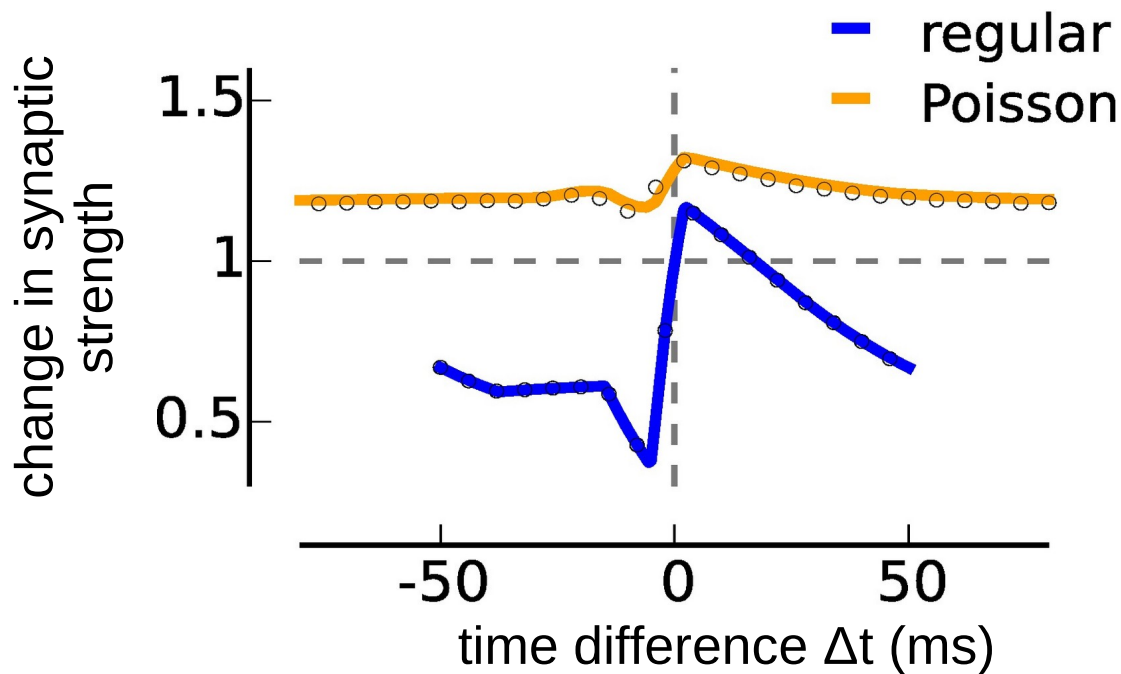

$$\nu_{\text{pre}} = \nu_{\text{post}} = 10 \text{ Hz}$$

Regular vs. irregular spike-pairs

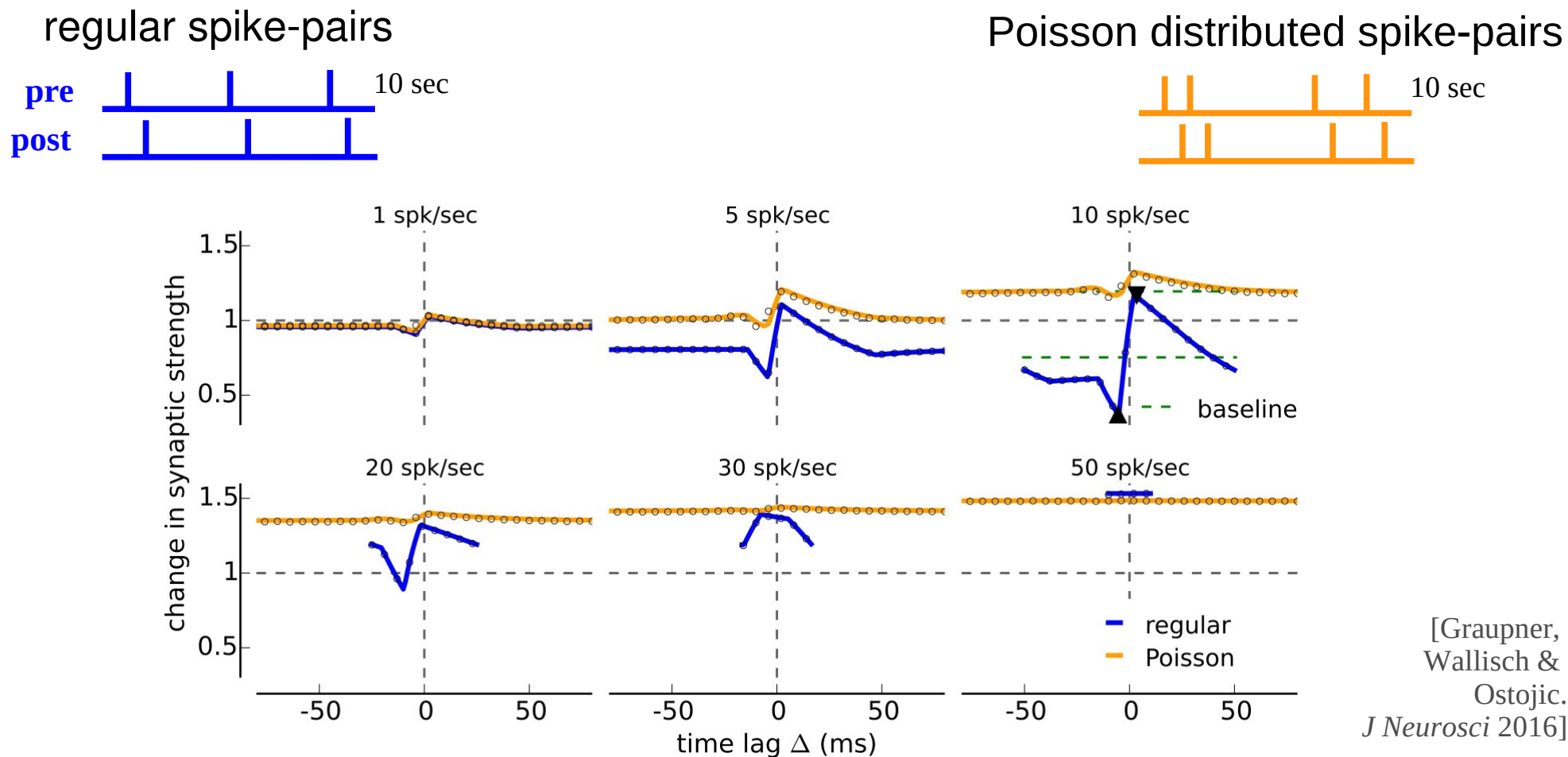

Conclusions

- STDP : temporally asymmetric form of synaptic plasticity induced by tight temporal correlations between the spikes of pre- and postsynaptic neurons
- induction: coincident pre- and postsynaptic activity lead to calcium influx through NMDA receptors, triggering intracellular signaling cascades
- biophysical model resolve various aspects of the synaptic machinery involved in plasticity induction, most commonly the postsynaptic calcium dynamics
- the role of STDP for learning in the living animal remains elusive