

# Introduction to computational neuroscience : from single neurons to network dynamics



Michael Graupner

*SPPIN, CNRS UMR 8003, Université Paris Cité*

slides : on the moodle or <https://biomedicale.u-paris.fr/~mgraupner/teaching.php> - [michael.graupner@u-paris.fr](mailto:michael.graupner@u-paris.fr)

# Lecture outline :

## Introduction to Computational Neurosciences

### **1. Introduction (today) :**

- A couple of (fun) brain questions

### **2. The Neuron (today) :**

- Hodgkin-Huxley model
- Integrate-and-Fire model
- Rate model
- Cable theory

### **3. Neural networks (next course) :**

- Rate models
- Spiking neuron models
- Examples

# What's the brain good for ?



Tree  
no neurons

C.elegans  
302 neurons

Fly  
1 000 000 neurons

Rat  
50 000 000 neurons

Human  
80 000 000 000 n.

The brain generates motion  
(=behavior)

more complex brains  
generate a greater  
variety of behaviors

more complex brains  
can learn more  
behaviors



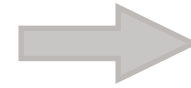
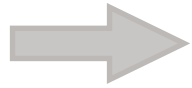

# Cognitive processing

stimulus

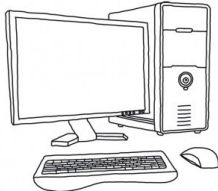

response

# What's the brain good at ?

			
chess	1	:	0
scrabble	1	:	0
Jeopardy!	1	:	0
video games	1	:	0
Go	1	:	0
Object recognition	1	:	1

Computers outperform humans in algorithmic tasks and tasks involving database mining.

# What's the brain good at ?

Lionel Messi – Barcelona : Getafe CF 2007



# What's the brain good at ?

RoboCup 2016

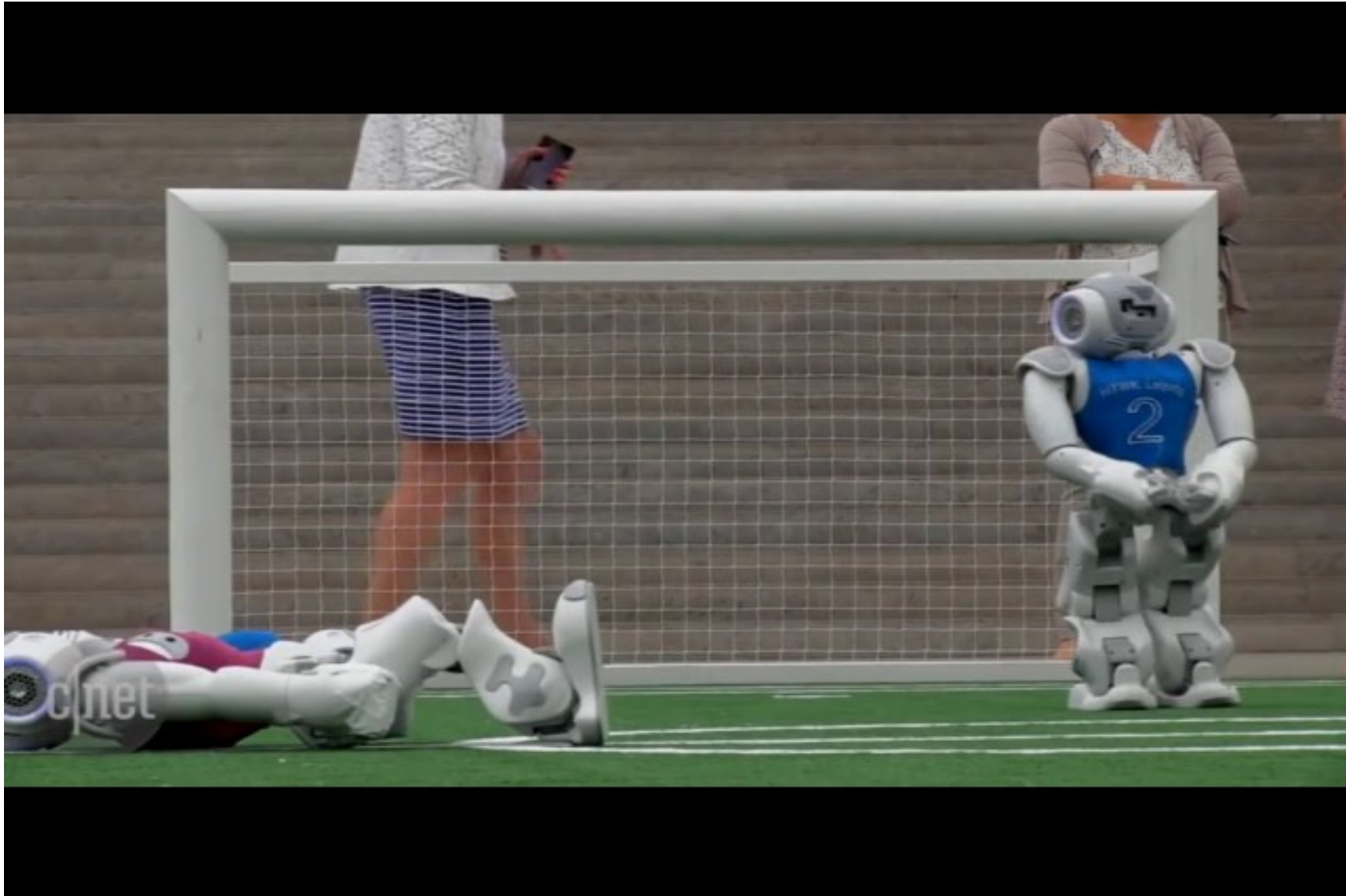

# What's the brain good at ?

Boston Dynamics

<https://www.youtube.com/watch?v=tF4DML7FIWk&t=7s>



# What's the brain good at ?

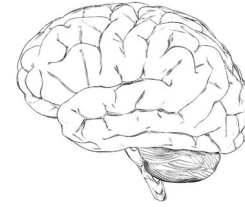

soccer

0

:

1

numerous  
motor  
tasks

0

:

1

(it's getting tight)

Brains are better in tasks involving interactions with the real world.

# Why model the brain ?

- to understand it
- to repair/improve it
- to get inspired

What makes  
modeling the  
brain so complex?

# The many spatial scales of the brain

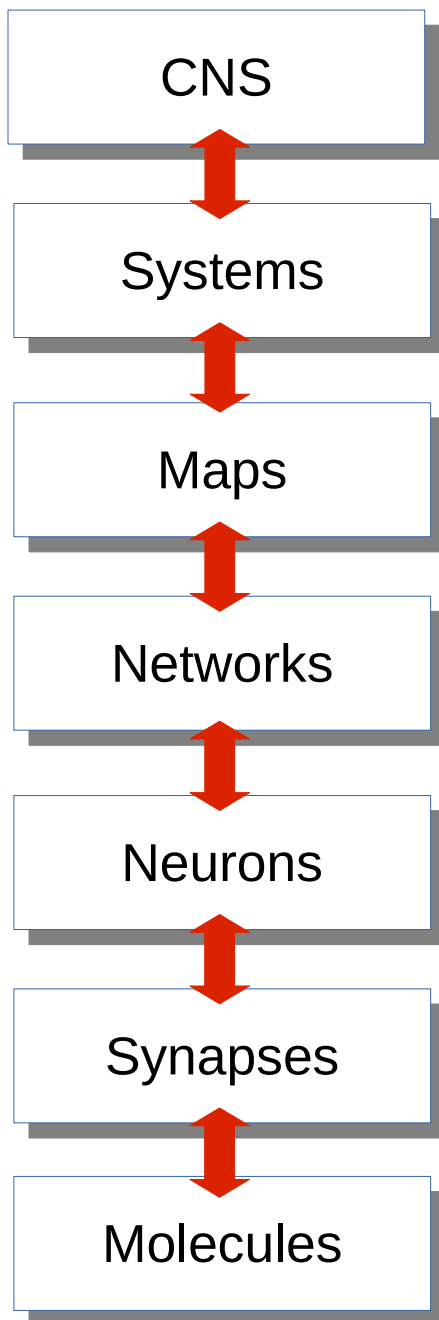

1 m

10 cm

1 cm

1 mm

100  $\mu\text{m}$

1  $\mu\text{m}$

1 nm

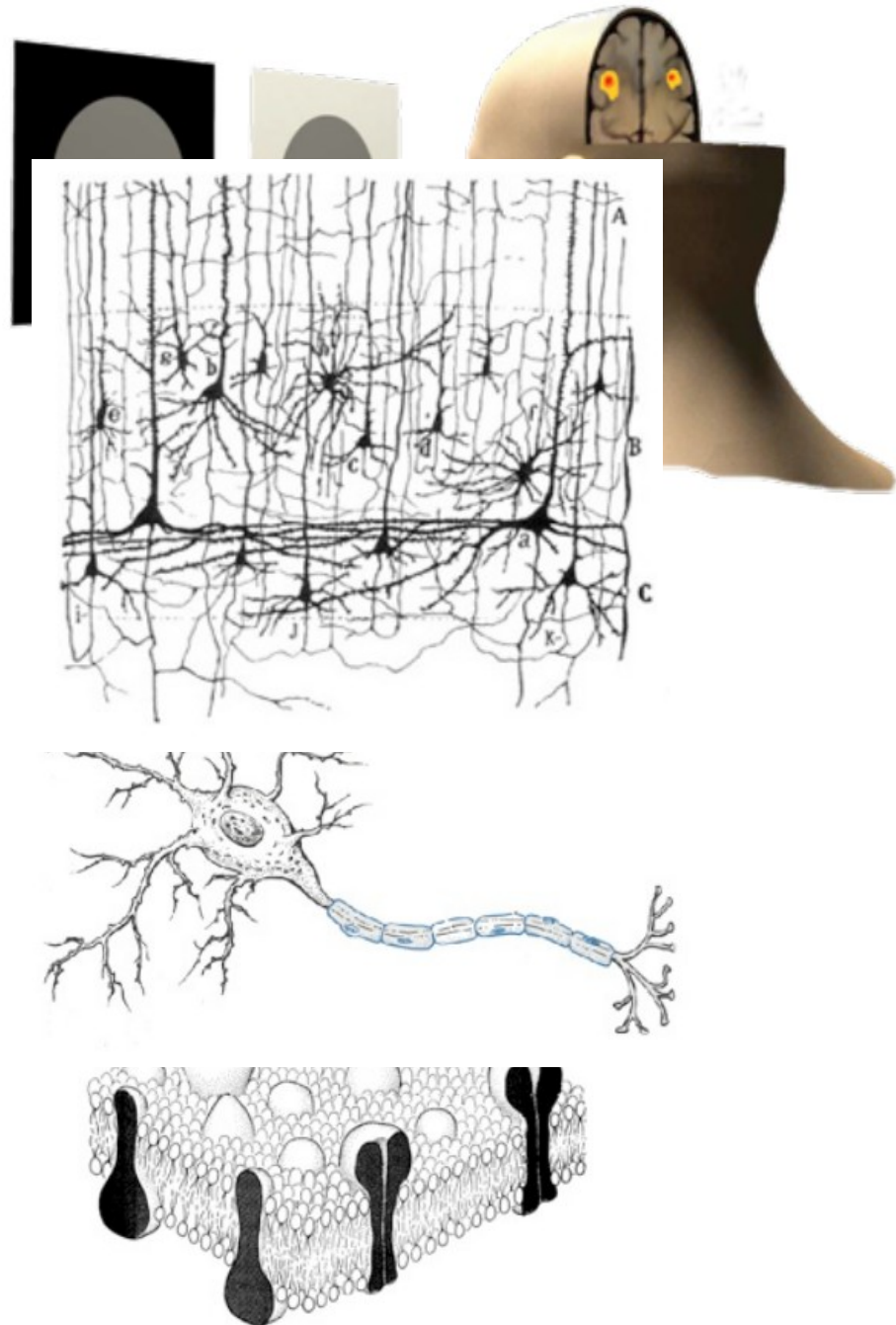

How does the  
brain work ?

# A physics/engineering approach

just rebuild the whole thing

 reverse engineering the brain

# The quest for mechanisms : Constructing the systems from parts

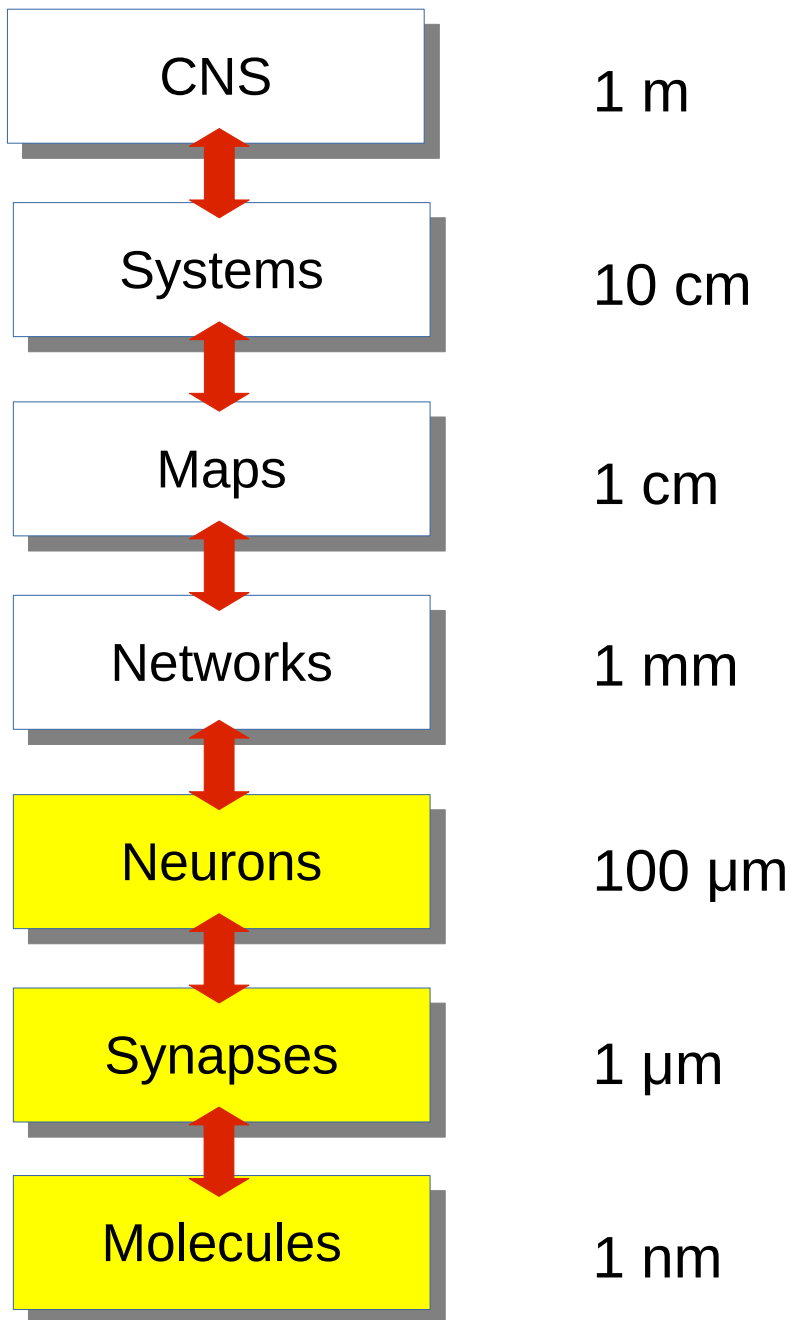

# The quest for mechanisms : Constructing the systems from parts

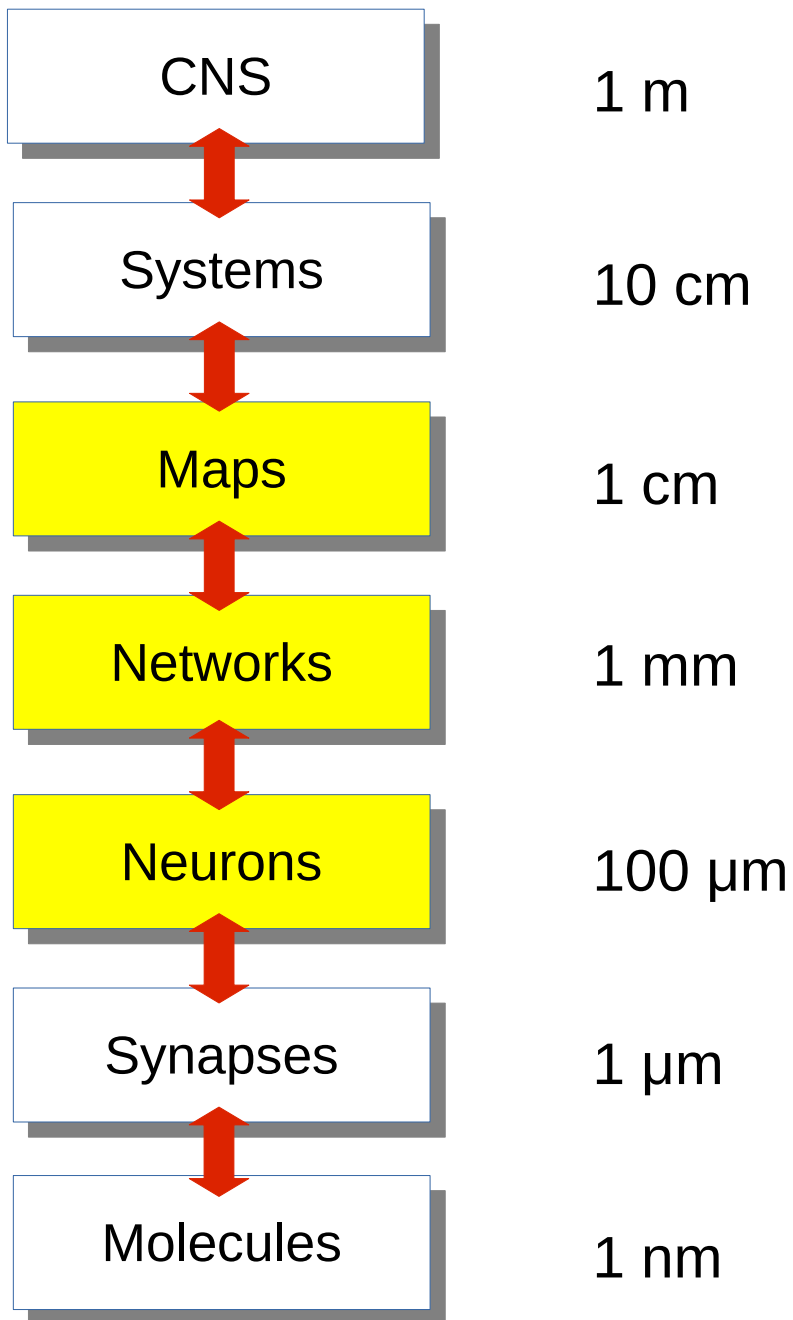



# A computer science approach

Study the computational  
problems

# Computation : manipulating information

## Normal hearing

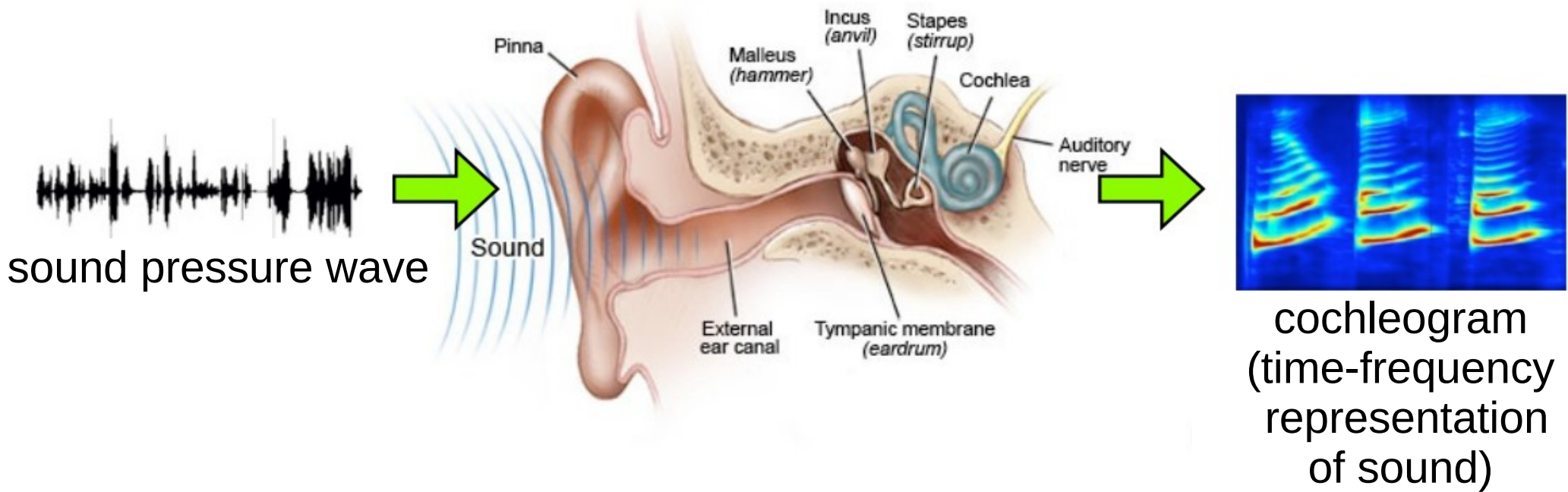

# Representation of information

**Music example :** Art Blakey – Mayreh

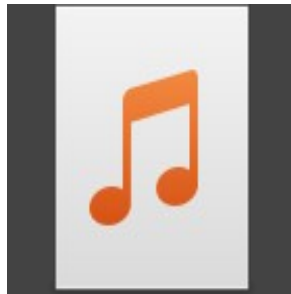

# Representation of information more or less lossy

How to transmit the music of a jazz concert :

- Partition



- Sound



- CD



- Language

The other day, I went to this cool jazz concert ... .



# Why represent information differently

**Example** : numbers, twenty-three

XXIII

Roman system

23

Decimal system

00010111

Binary system

# Why represent information differently

**Example** : numbers, twenty-three

XXIII	in ... ?
23	in multiples of 10
00010111	in multiples of 2

Can you add these number ?

$$\begin{array}{r} 29 \\ + 33 \\ \hline 62 \end{array}$$

$$\begin{array}{r} 00011101 \\ + 00100001 \\ \hline 00111110 \end{array}$$

$$\begin{array}{r} XXIX \\ + XXXIII \\ \hline LXII \end{array}$$

# Most famous example “edge detectors” in visual cortex

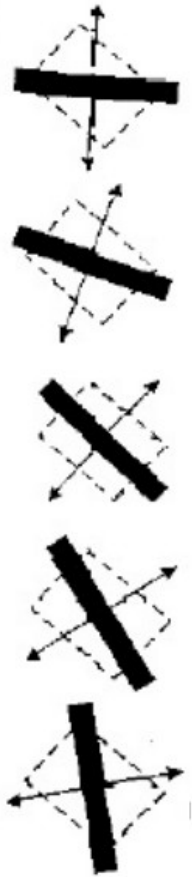

stimulus:  
black  
bar

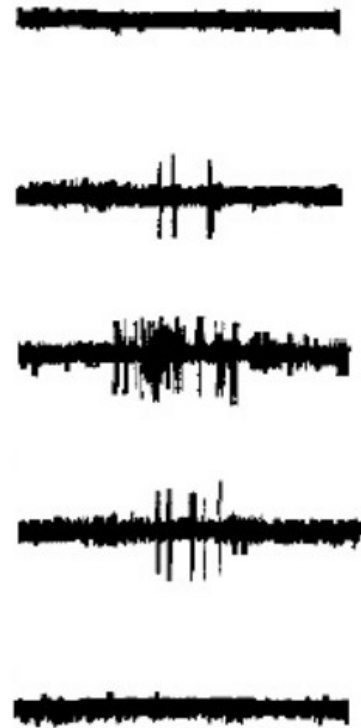
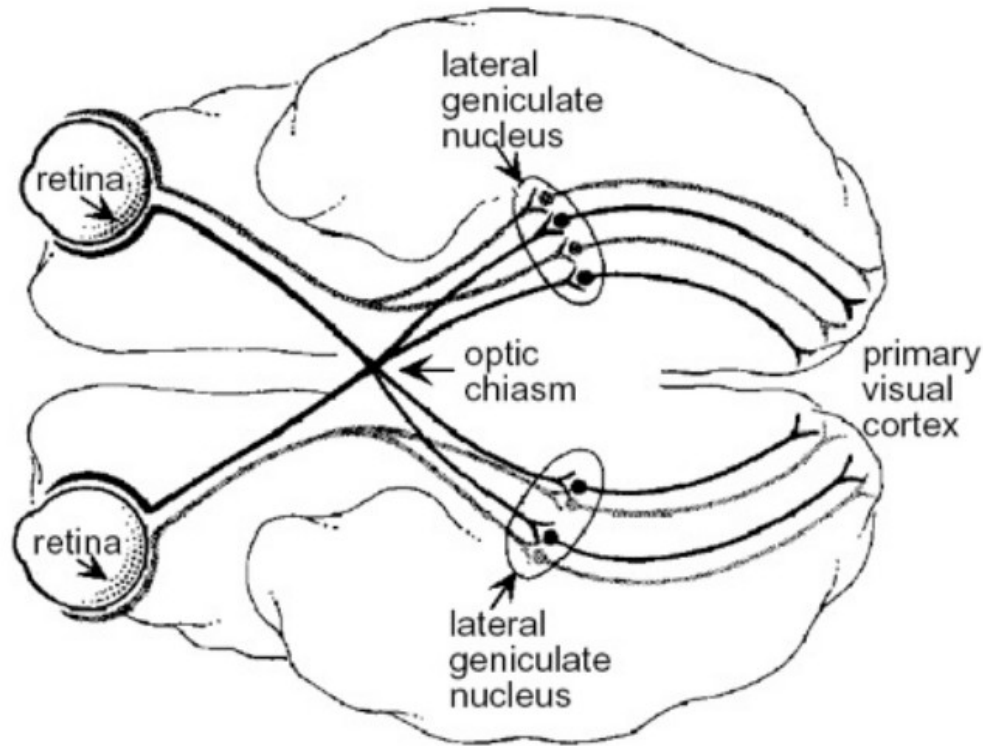

Activity of  
neuron in  
visual cortex  
(V1)

# Another famous example “Place cells” in the hippocampus

## Linear track





# Another famous example “Place cells” in the hippocampus



# What we understand

very little



# What is required

## **biologists, psychologist**

- to probe the brains of animals and humans
- to design and carry out clever experiments
- to investigate and quantify human and animal behavior



## **physicists, computer scientists, engineers**

- to formulate mathematical theories of information processing
- to create biophysical models of neural networks

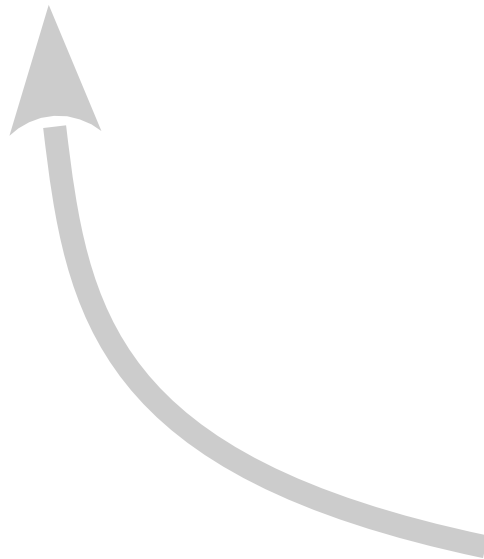

# Lecture outline :

## Introduction to Computational Neurosciences

### **1. Introduction (today) :**

- A couple of (fun) brain questions

### **2. The Neuron (today) :**

- Hodgkin-Huxley model
- Integrate-and-Fire model
- Rate model
- Cable theory

### **3. Neural networks (next week) :**

- Rate models
- Spiking neuron models
- Examples

# What does the hardware look like ?

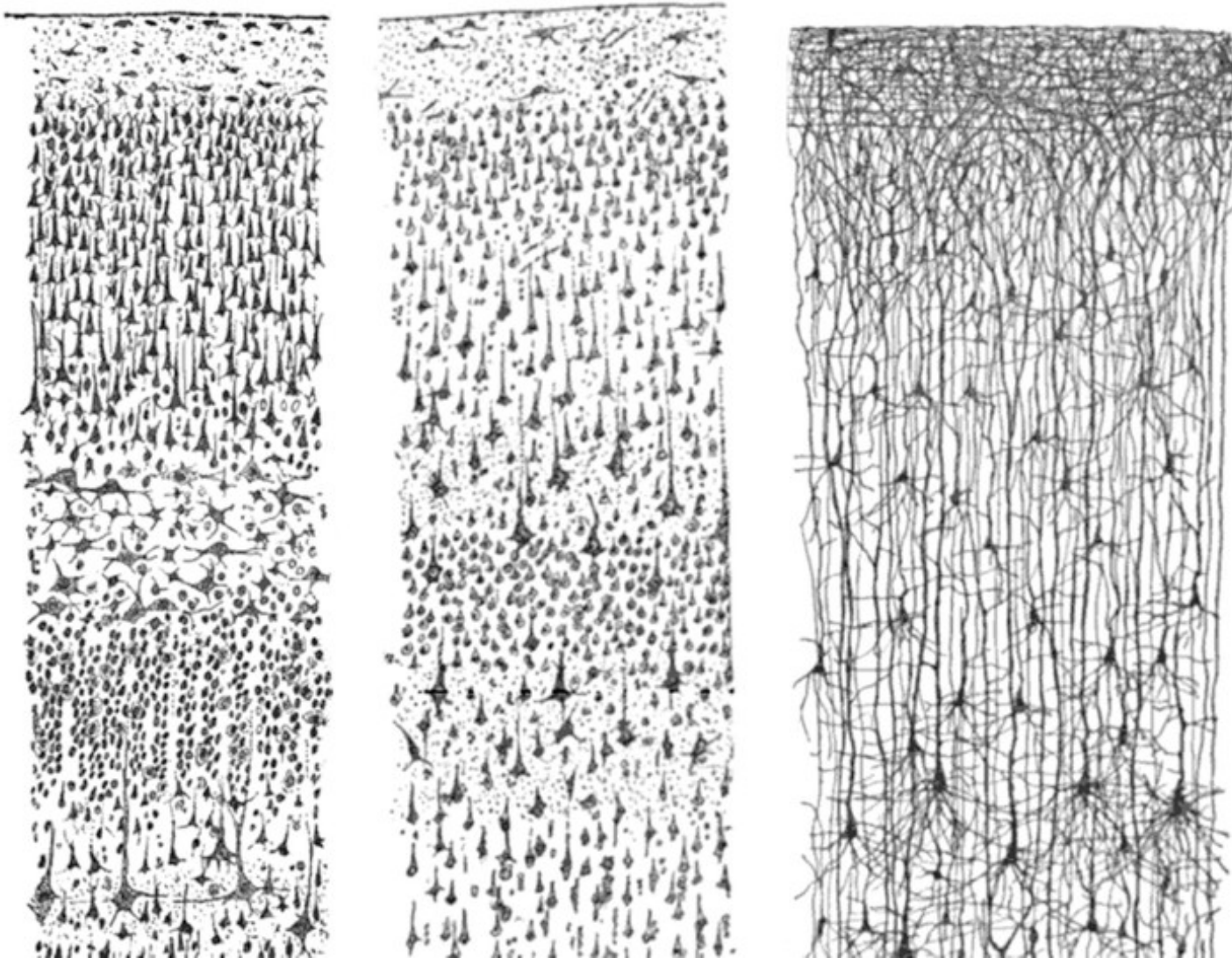

Ramon y Cajal (Nobel Prize 1906)

Joseph von Gerlach (1871), Camillo Golgi



neuron doctrine



~~Reticular theory~~

# Neurons = basic units of computation

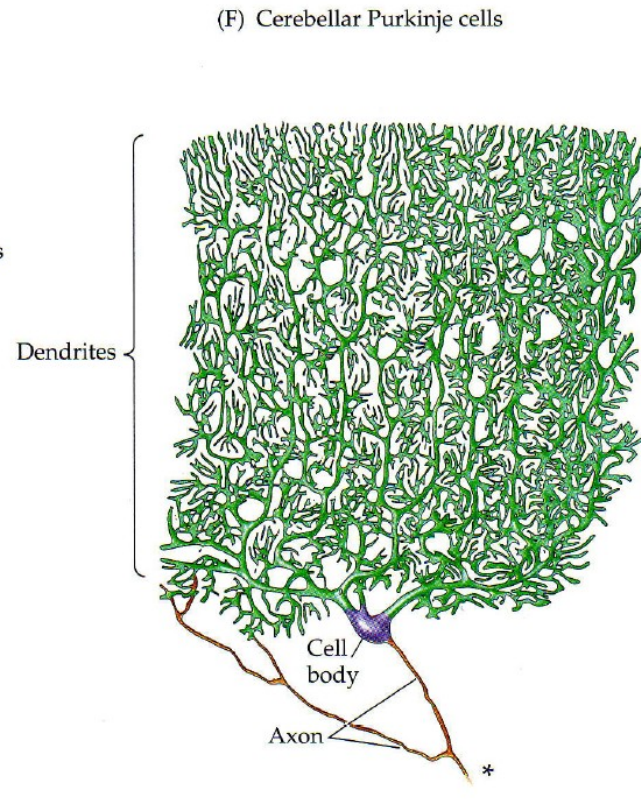
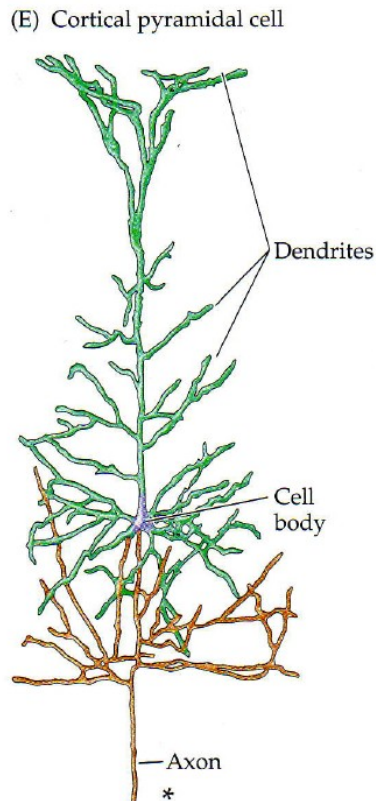
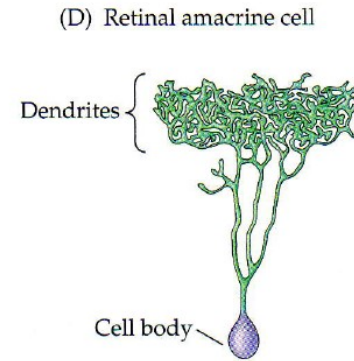
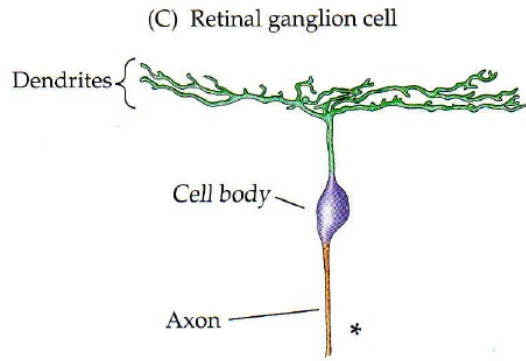
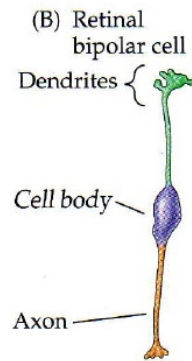

Dendrites

Soma

Axon

information flow



# The typical cortical neuron

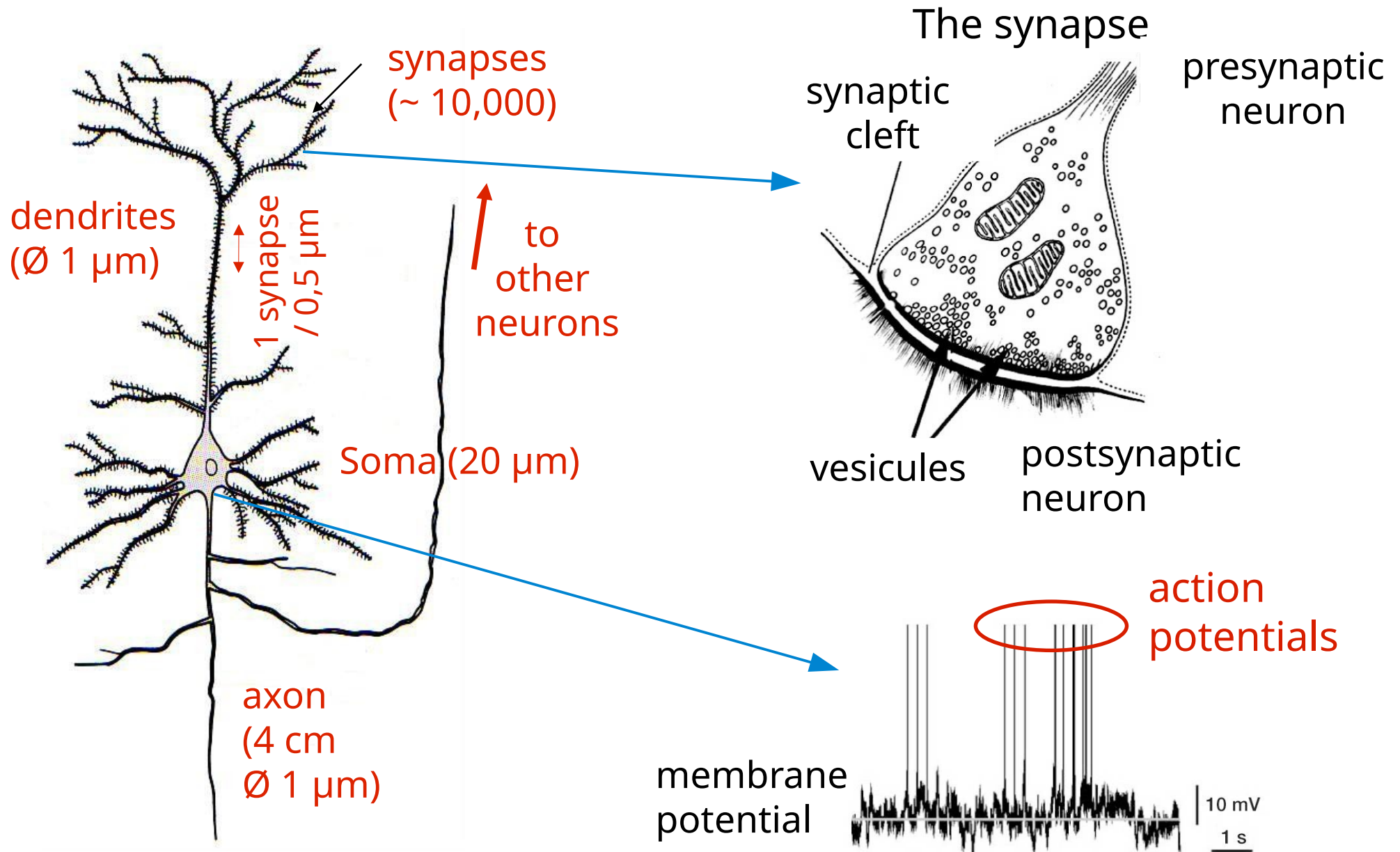

# Neural integration

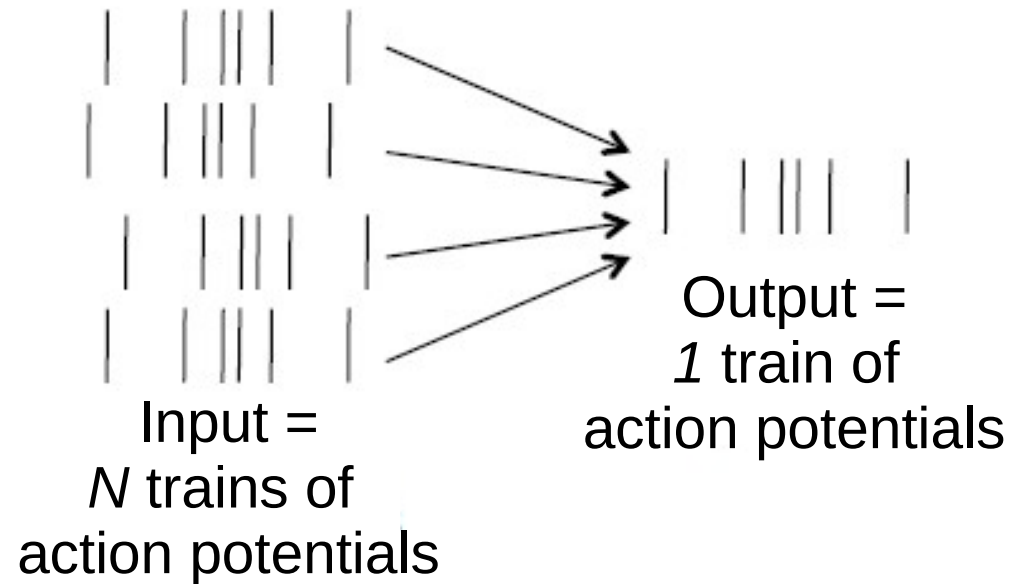
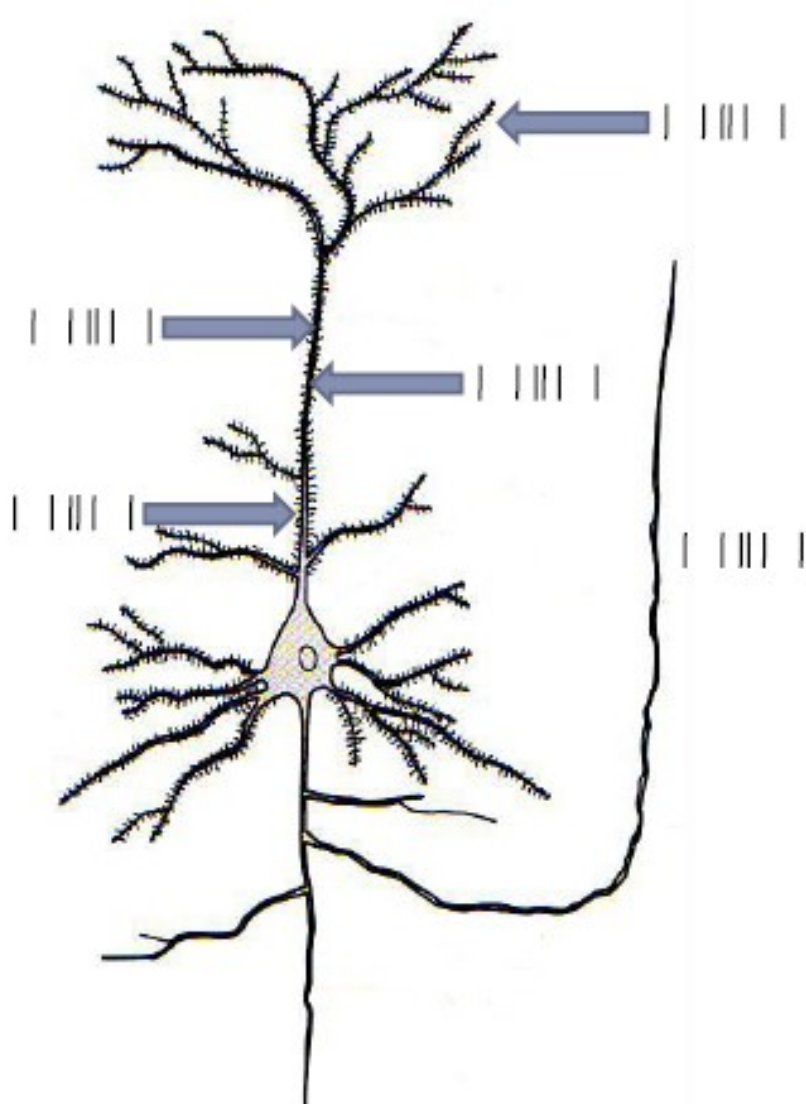

Synaptic current of one specific synapse ( $ij$ ) :

$$I_s = G_{max} \Delta V \alpha(t) = w_{ij} \alpha(t)$$

Total synaptic current in neuron  $i$  at time  $t$  :

$$I_{syn}^i(t) = \sum_j w_{ij} \sum_k \alpha(t - t_j^{(k)})$$



# Neural integration

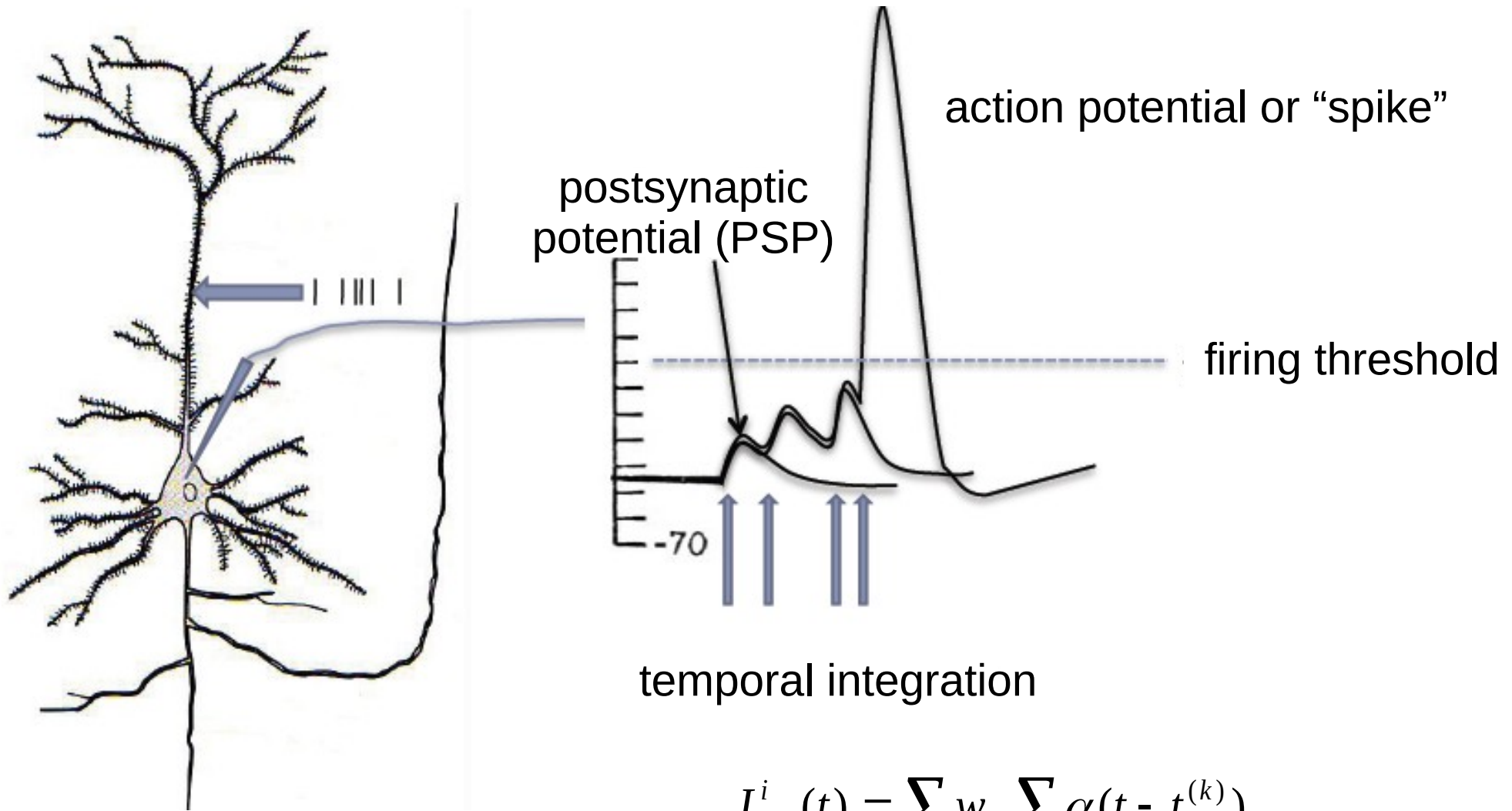

$$I_{syn}^i(t) = \sum_j w_{ij} \sum_k \alpha(t - t_j^{(k)})$$

# Single neuron models

- **Hodgkin Huxley model** : description of ion channel dynamics (Hodgkin & Huxley, 1952)
- **integrate-and-fire model** : description of input integration membrane potential dynamics (LaPicque, 1907)
- **rate model** : description of the mean firing rate dynamics
- **cable theory** : description of input propagation along the dendrites (Rall, 1962)

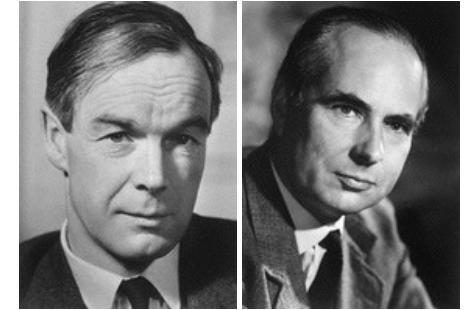

Hodgkin

Huxley

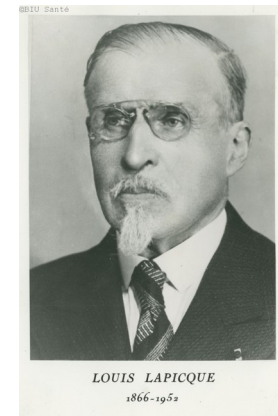

Wilfrid Rall

# Significance of the Hodgkin-Huxley model

- Hodgkin and Huxley performed first intracellular recording of an action potential

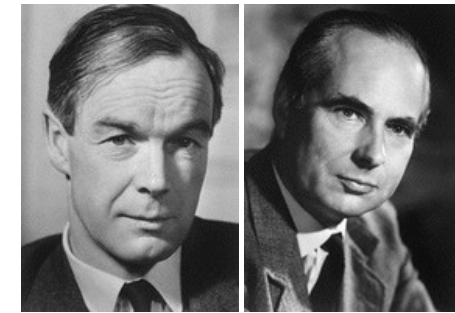
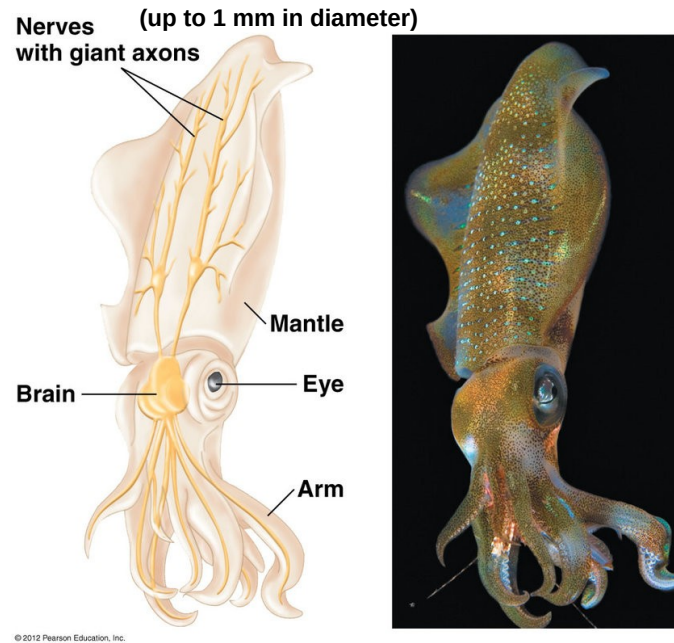
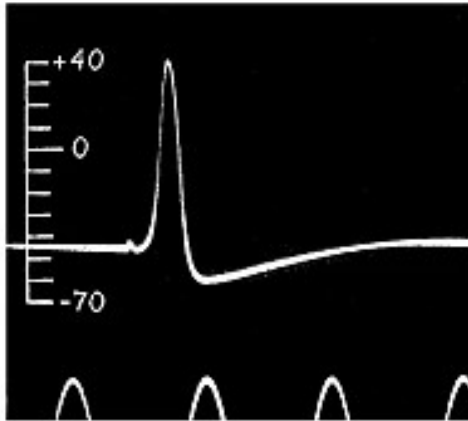

Hodgkin

Huxley

- using voltage-clamp protocol : demonstrated that two independent currents are underlying action potential – sodium and potassium
- empirical representation of the experimental data in a quantitative model : the Hodgkin-Huxley model -> links the microscopic level of ion channels to the macroscopic level of currents and action potentials

# Simplified single neuron : single compartment model

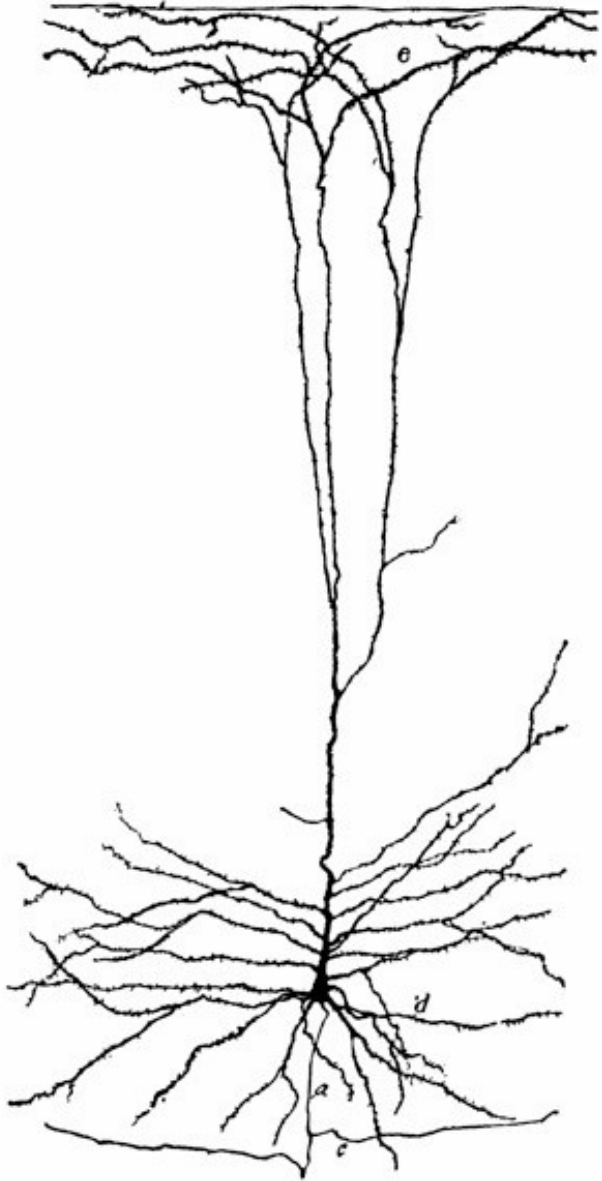

# The membrane

- Lipid bilayer (= capacitance) with pores (channels = proteines)

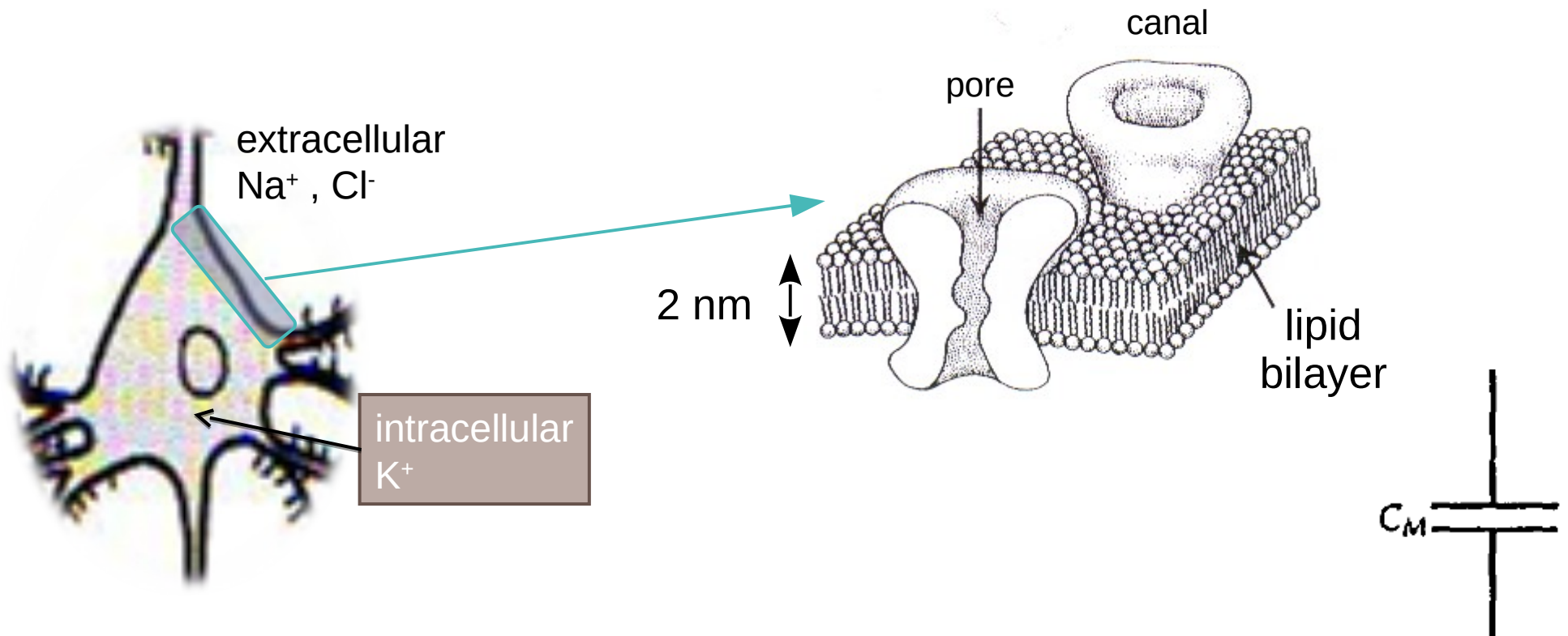

specific capacitance  $1 \mu\text{F}/\text{cm}^2$   
total specific capacitance = specific capacitance \* surface

# Physics reminder

## Ohm's law :

The current flowing through a resistor is directly proportional to the voltage drop across the resistor.

$$I = \frac{V}{R} \quad R = \frac{1}{g}$$

## Kirchoff's law :

The sum of currents flowing into a point is equal to the sum of currents flowing out of that point..

$$I_1 + I_2 + I_3 + \dots = 0$$

# Membrane properties : equivalent circuit

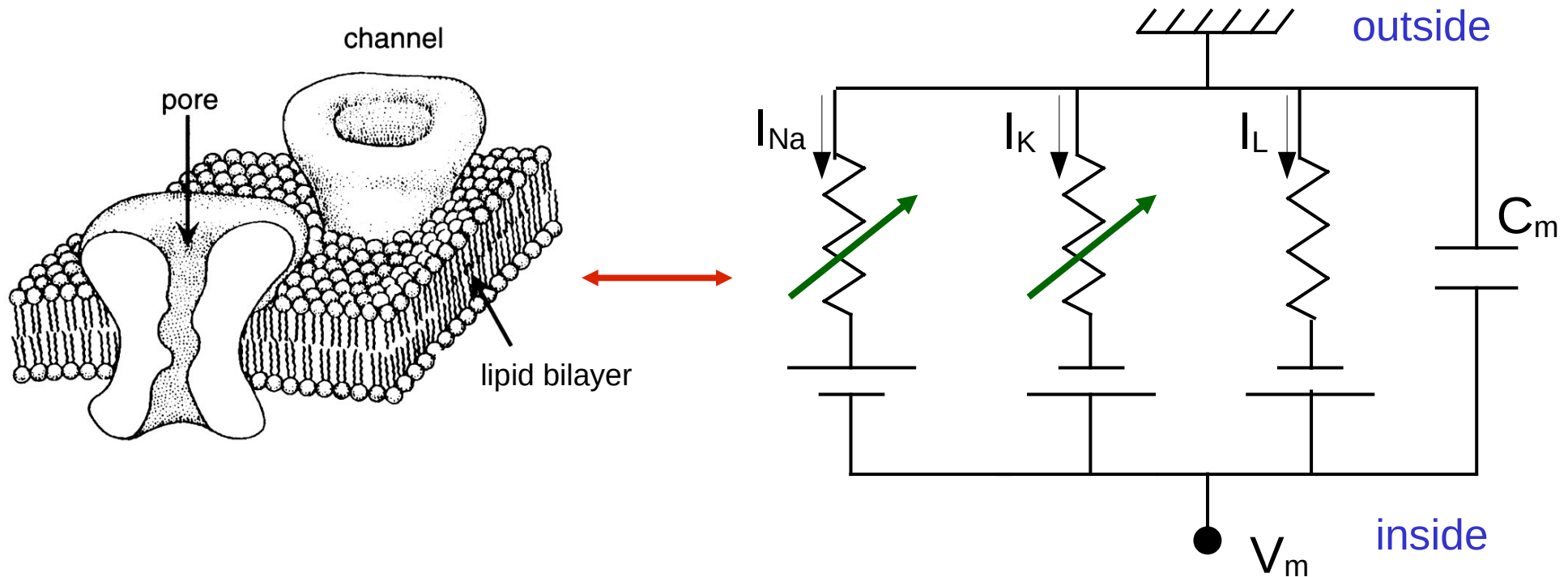

- The membrane potential  $V_m$  varies due to the opening/closing of different types of ion channels.
- “**Active membrane**” : Ion channel conductance varies with the membrane potential.

# Hodgkin-Huxley model : membrane potential equation

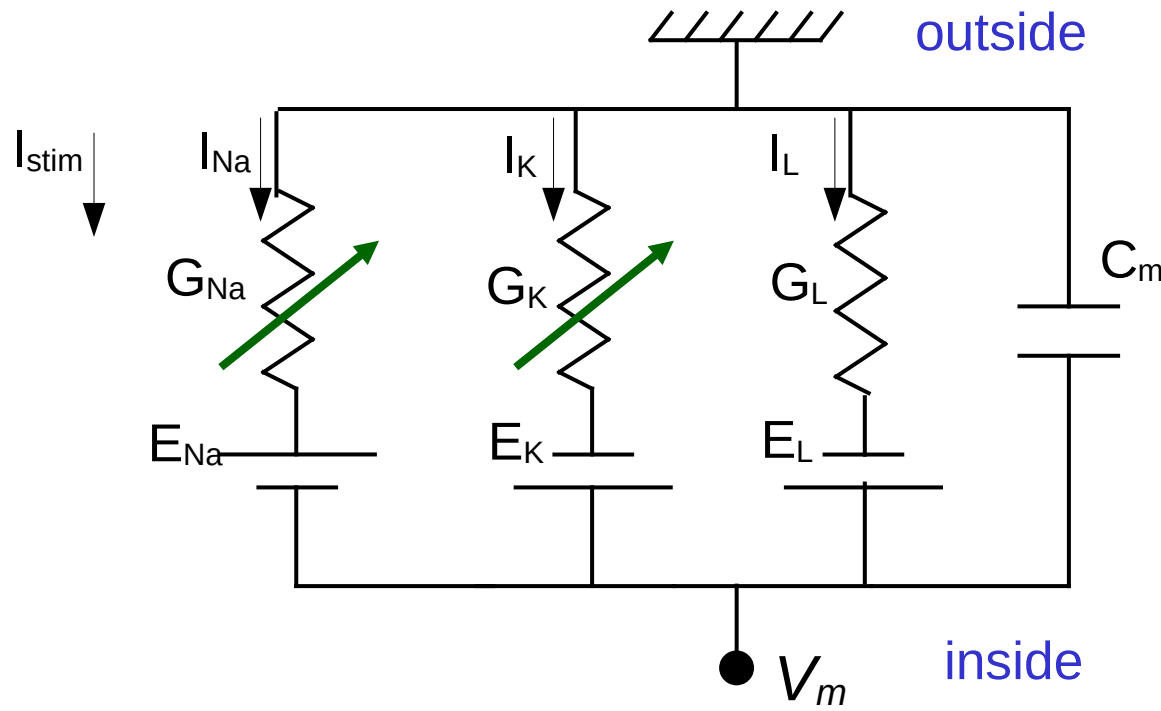

Kirchhoff's law :

$$I_{stim} = I_{Na} + I_k + I_L + I_C$$

Ohm's law :

$$R = \frac{\Delta V}{I} \quad \longrightarrow \quad I = \frac{\Delta V}{R} = g(V_m - V_{rev})$$

$$\longrightarrow I_{stim} = g_{Na}(t)(V_m - V_{Na}) + g_K(t)(V_m - V_K) + g_L(V_m - V_L) + C \frac{dV_m}{dt}$$



# Hodgkin-Huxley model : potassium channel

→ 4 similar sub-units

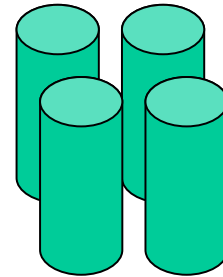

→ Each subunit can be « open » or « closed » :

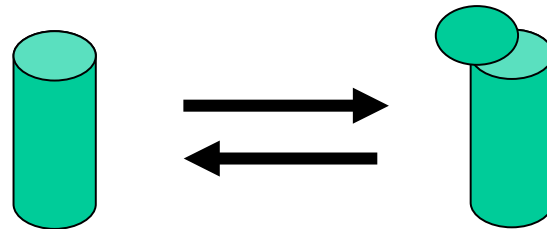

→ The channel is « open » if and only if all the sub-units are « open »

# Hodgkin-Huxley model : potassium channel

- probability that one sub-unit is « open » :  $n(t)$
- probability that all sub-units are « open » :  $n(t)^4$
- maximal K<sup>+</sup> conductance, when all channels are open :  $\bar{g}_K$
- K<sup>+</sup> conductance :  $g_k = \bar{g}_K n(t)^4$

$$C \frac{dV}{dt} = g_{Na}(t)(V_{Na} - V) + g_K(t)(V_K - V) + g_L(V_L - V) + I_{stim}$$



$$C \frac{dV}{dt} = g_{Na}(t)(V_{Na} - V) + \bar{g}_K n(t)^4 (V_K - V) + g_L(V_L - V) + I_{stim}$$

# Hodgkin-Huxley model : potassium channel

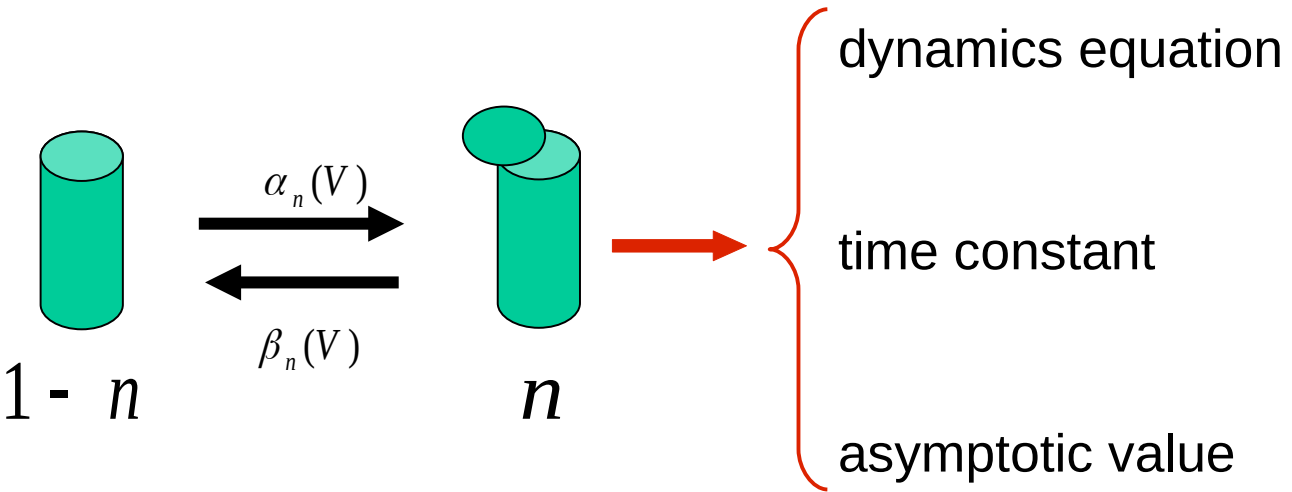

$$\tau_n \frac{dn}{dt} = -n + n_\infty$$

$$\tau_n = \frac{1}{\alpha_n + \beta_n}$$

$$n_\infty = \frac{\alpha_n}{\alpha_n + \beta_n}$$

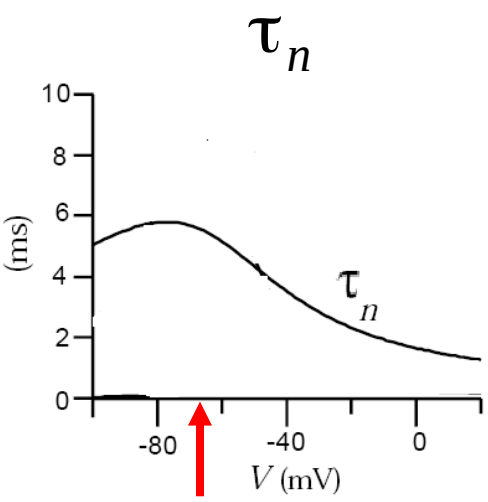
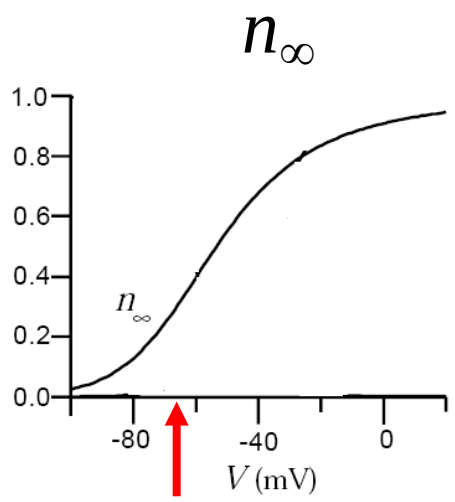

→ The potassium channel is closed at resting potential.

# Math reminder : difference quotient

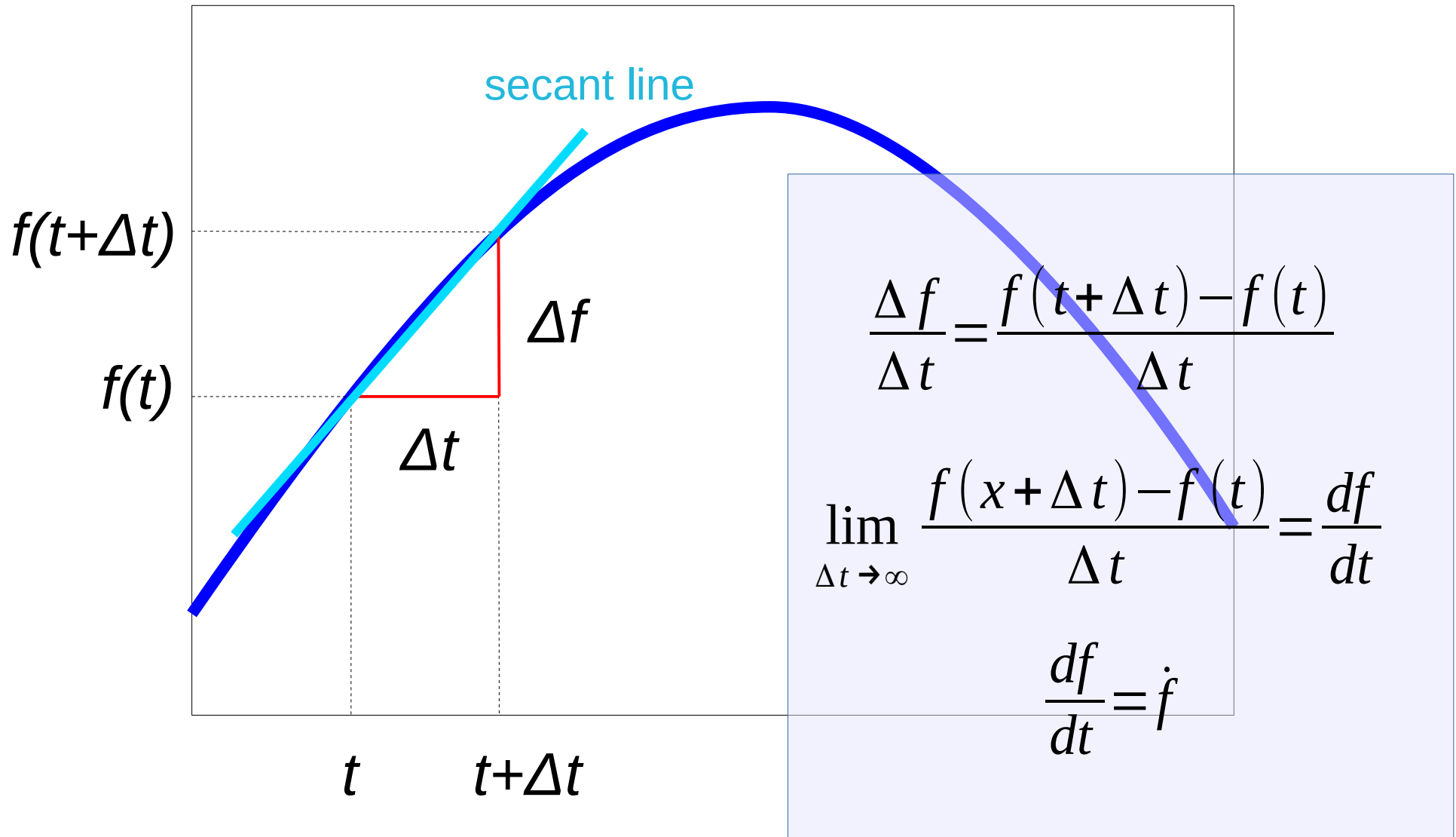

# Hodgkin-Huxley model : sodium channel

- The sodium channel has 3 similar « fast » esub-units and 1 « slow » subunit

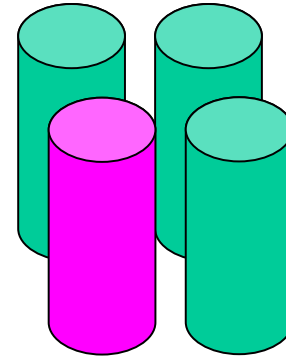

- Each sub-unit can be « open » or « closed »

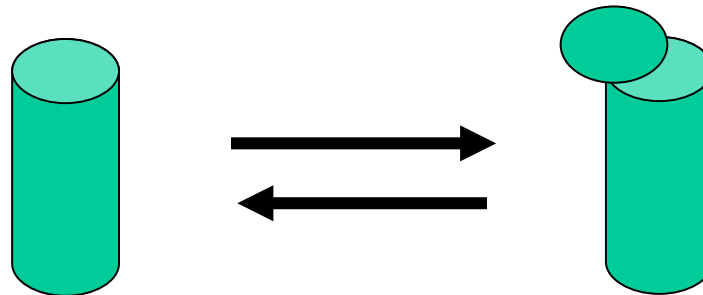

- The channel is « open » if and only if all the sub-units are « open »

# Hodgkin-Huxley model : sodium channel

- Probability that the « fast » sub-unit is « open » :  $m$
- Probability that the « slow » sub-unit is « open » :  $h$
- Probability that the channel is « open » :  $m^3 h$
- Maximal Na<sup>+</sup> conductance, when all channels are open :  $\bar{g}_{Na}$
- Na<sup>+</sup> conductance :  $g_{Na} = \bar{g}_{Na} m^3 h$

$$C \frac{dV}{dt} = g_{Na} (V_{Na} - V) + g_K (V_K - V) + g_L (V_L - V) + I_{ext}$$



$$C \frac{dV}{dt} = \bar{g}_{Na} m^3 h (V_{Na} - V) + \bar{g}_K n^4 (V_K - V) + g_L (V_L - V) + I_{stim}$$

# Hodgkin-Huxley model : sodium channel

dynamics of the fast sub-unit

$$\tau_m \frac{dm}{dt} = -m + m_\infty$$

$$\tau_m = \frac{1}{\alpha_m + \beta_m}$$

$$m_\infty = \frac{\alpha_m}{\alpha_m + \beta_m}$$

dynamics of the slow sub-unit :

$$\tau_h \frac{dh}{dt} = -h + h_\infty$$

$$\tau_h = \frac{1}{\alpha_h + \beta_h}$$

$$h_\infty = \frac{\alpha_h}{\alpha_h + \beta_h}$$

asymptotic values

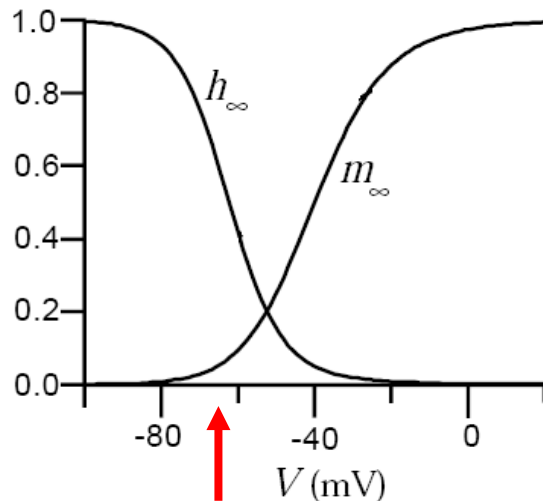

time constants

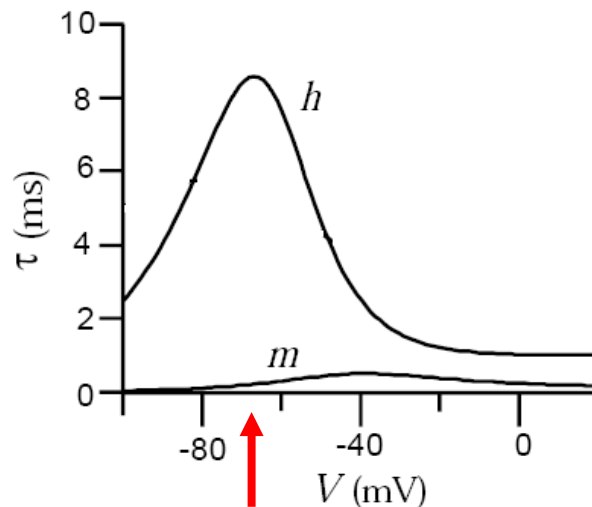

- The fast sub-unit is closed at resting potential.
- The slow sub-unit is open at resting potential.
- The sodium channel is closed at resting potential.

# Complete equations of the Hodgkin-Huxley model

$$C \frac{dV}{dt} = \bar{g}_{Na} m^3 h (V_{Na} - V) + \bar{g}_K n^4 (V_K - V) + g_L (V_L - V) + I_{stim}$$

$$\tau_n \frac{dn}{dt} = -n + n_\infty, \tau_n = \frac{1}{\alpha_n + \beta_n}, n_\infty = \frac{\alpha_n}{\alpha_n + \beta_n}$$

$$\tau_m \frac{dm}{dt} = -m + m_\infty, \tau_m = \frac{1}{\alpha_m + \beta_m}, m_\infty = \frac{\alpha_m}{\alpha_m + \beta_m}$$

$$\tau_h \frac{dh}{dt} = -h + h_\infty, \tau_h = \frac{1}{\alpha_h + \beta_h}, h_\infty = \frac{\alpha_h}{\alpha_h + \beta_h}$$

$$\alpha_n(V) = \frac{(0.1 - 0.01V)}{e^{1-0.1V} - 1}$$

$$\alpha_m(V) = \frac{(2.5 - 0.1V)}{e^{2.5-0.1V} - 1}$$

$$\alpha_h(V) = 0.07 e^{-\frac{V}{20}}$$

$$\beta_n(V) = 0.125 e^{-\frac{V}{80}}$$

$$\beta_m(V) = 4 e^{-\frac{V}{18}}$$

$$\beta_h(V) = \frac{1}{e^{3-0.1V} + 1}$$



# Hodgkin-Huxley model : the action potential

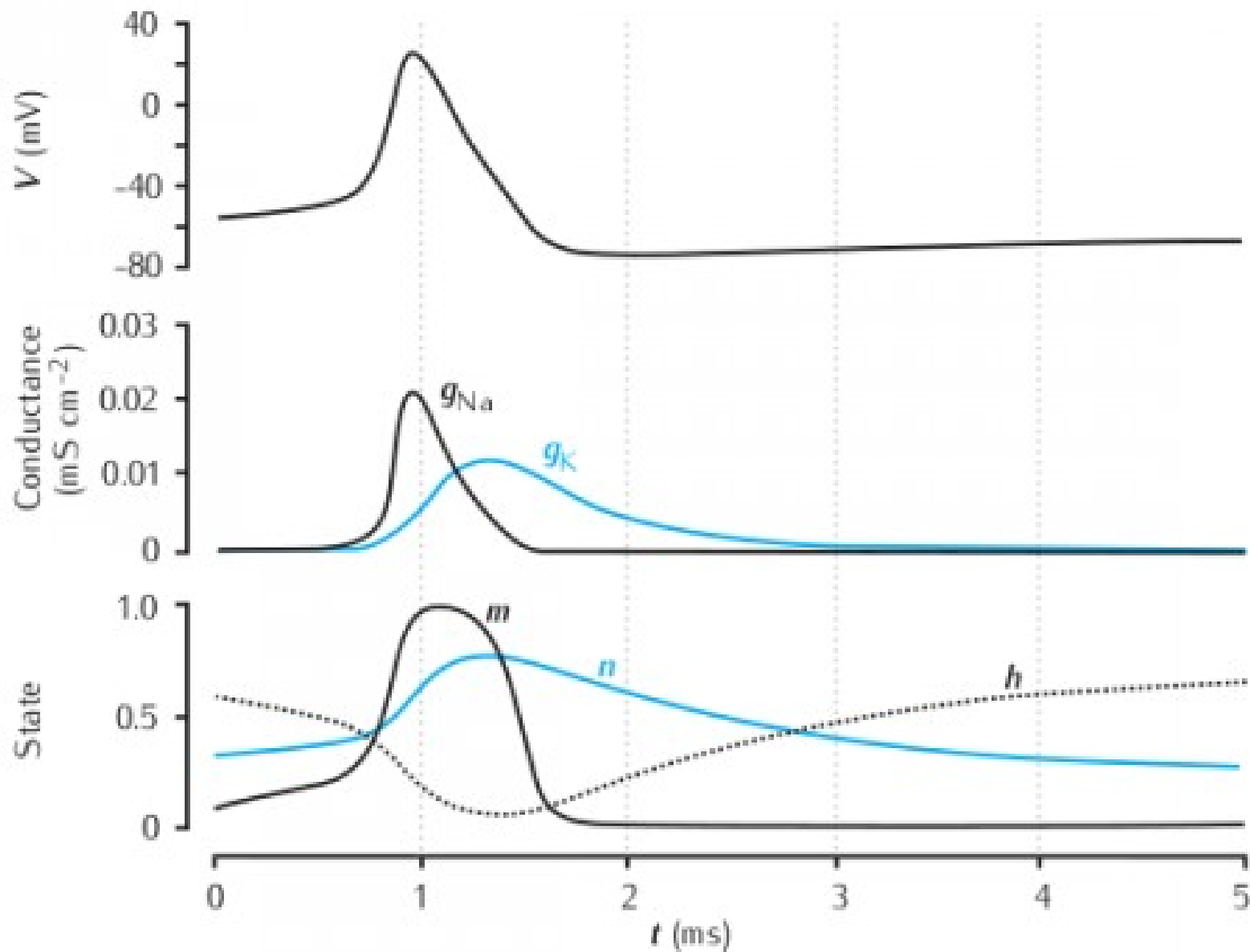

# Hodgkin-Huxley model : the action potential

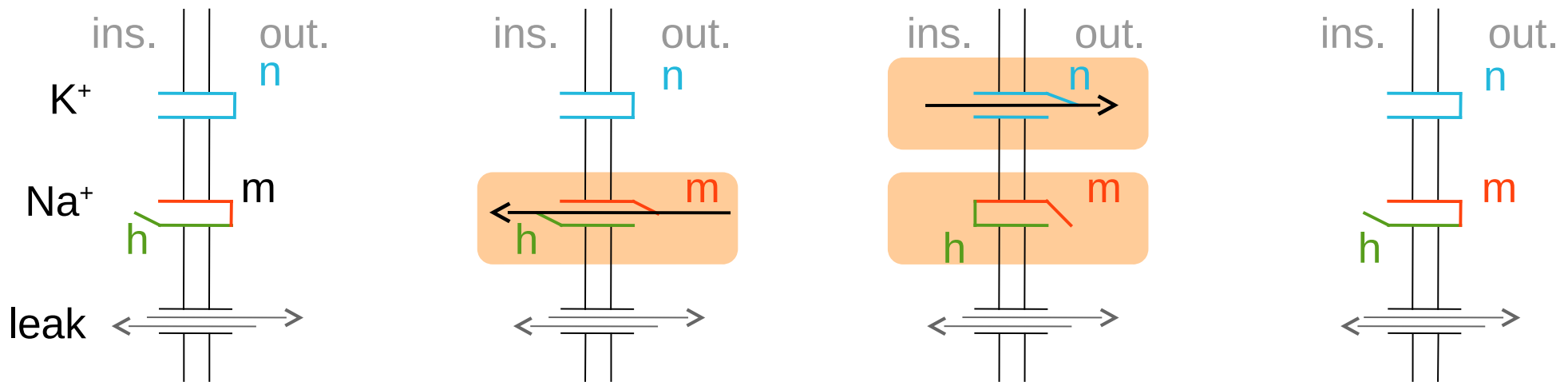
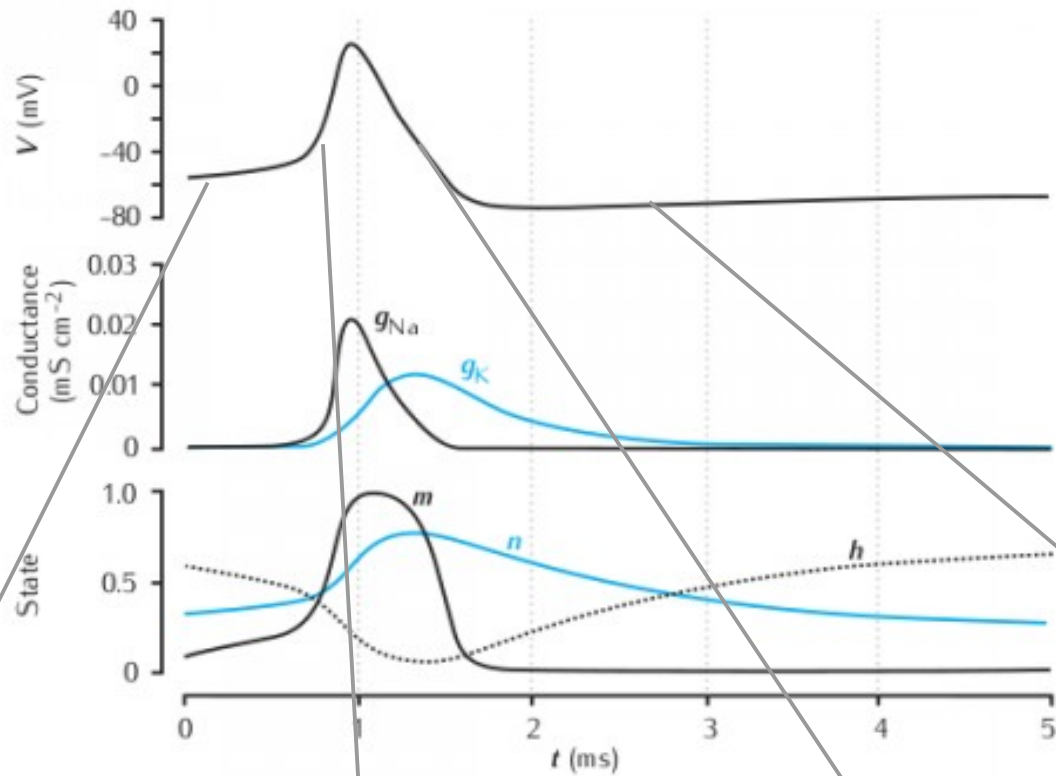

# Hodgkin-Huxley model : current injection

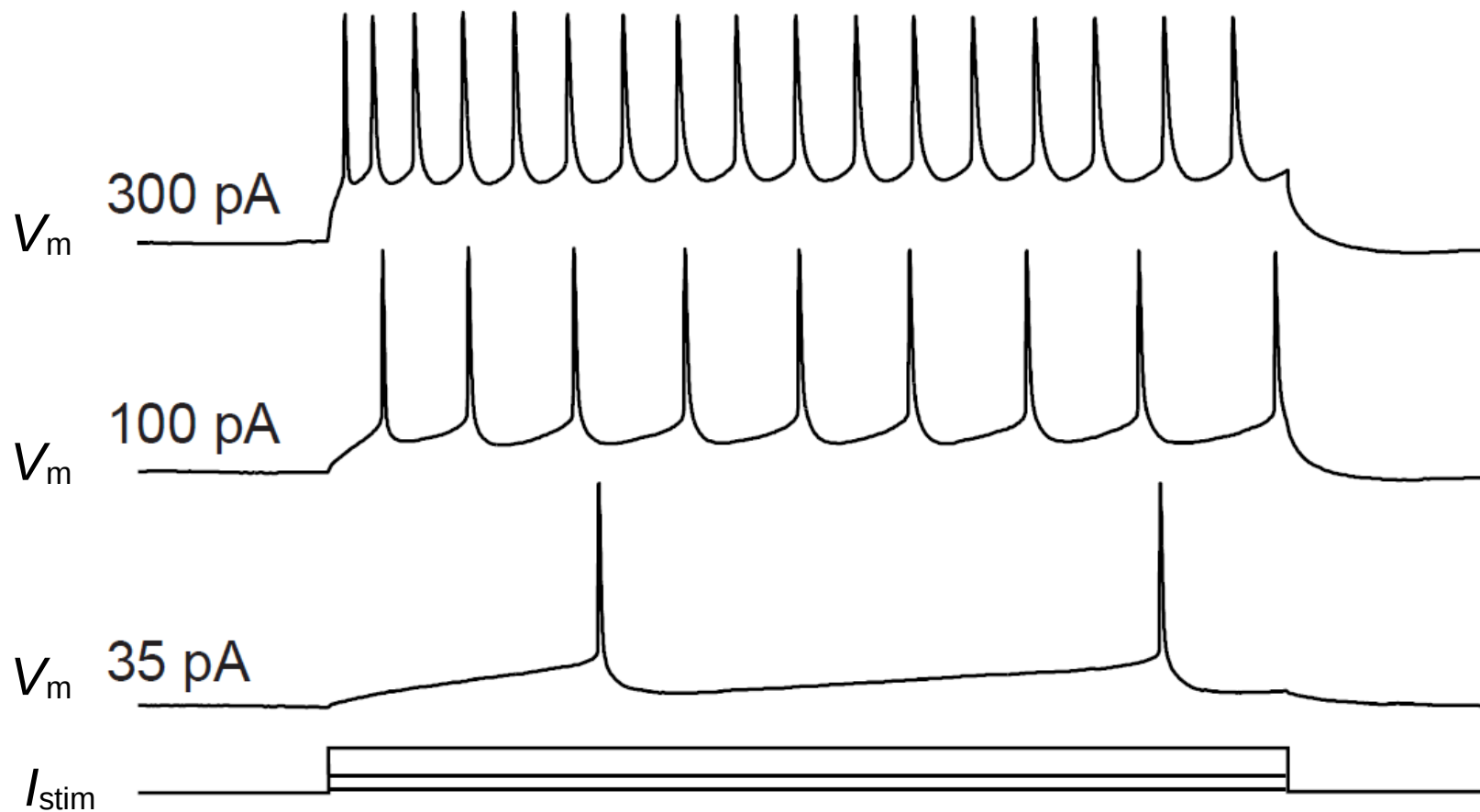

# Hodgkin-Huxley model : F-I curve

**Example** : study the role of the membrane permeability (conductance  $g_L$ ) on action potential output

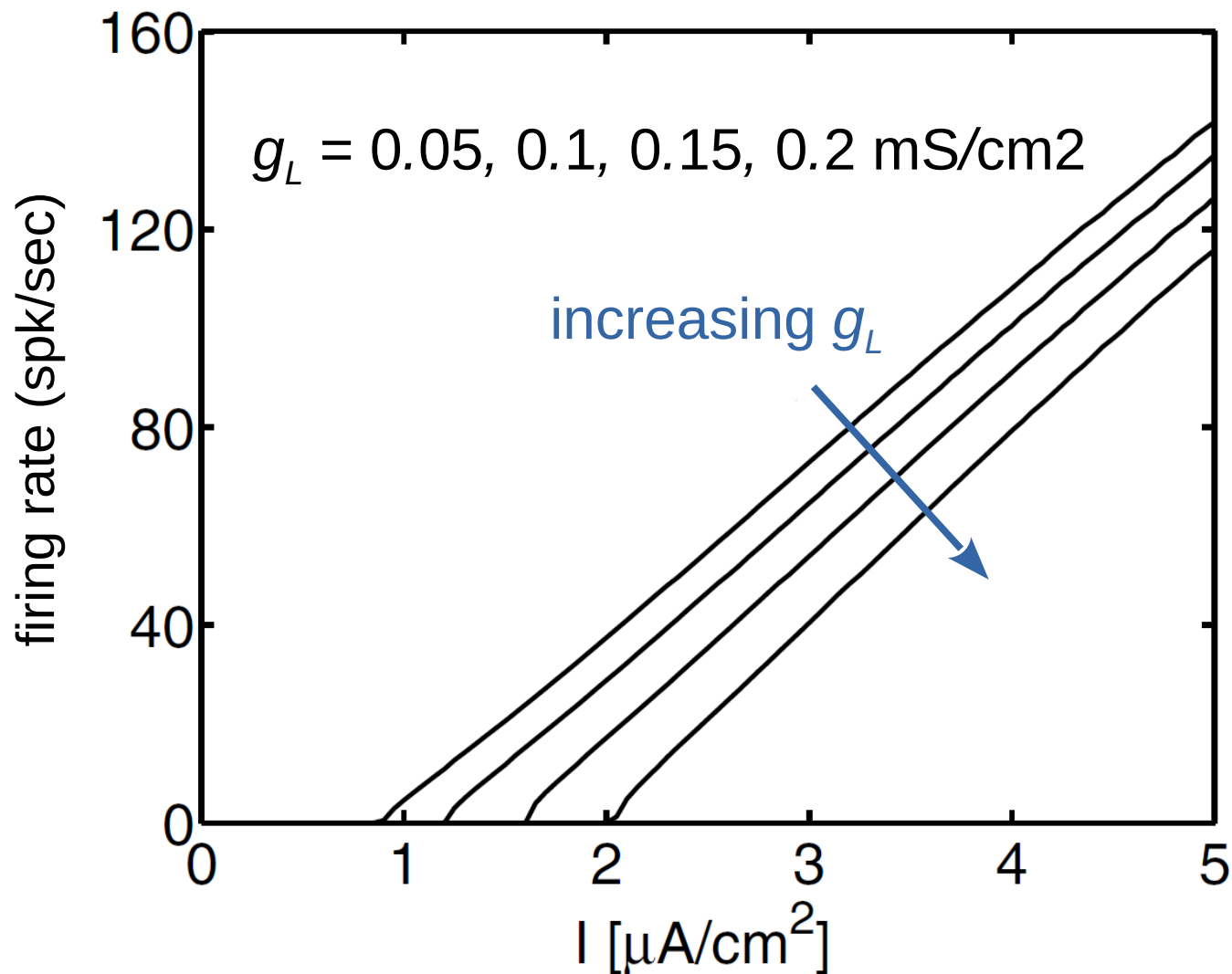

# Neural integration

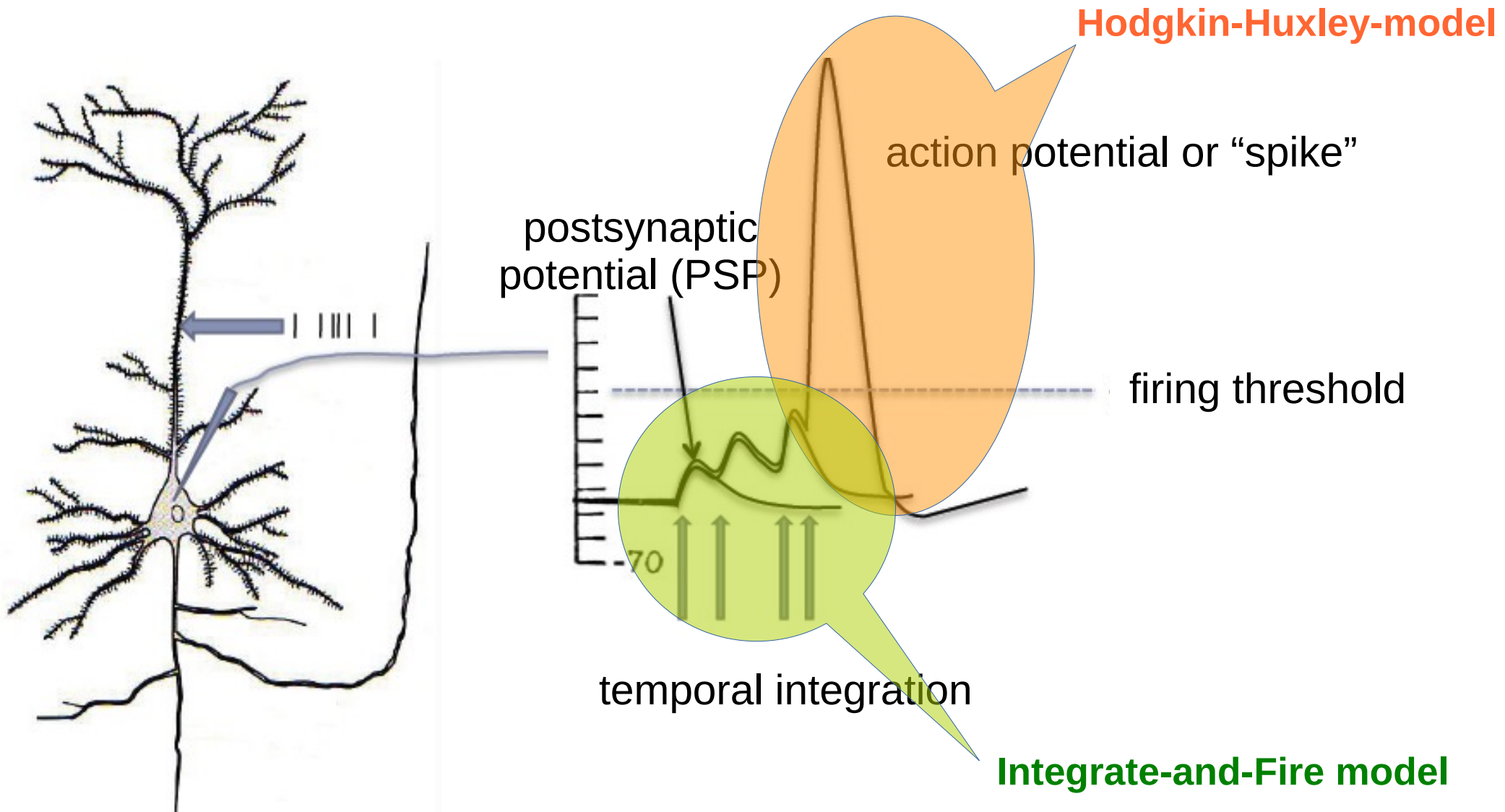

# Integrate-and-Fire model : derivation

**simplification** : no active currents  $\longrightarrow g(t) = \text{const.}$

→ The shape of the action potential is not described !

$$C \frac{dV}{dt} = g_{Na} (V_{Na} - V) + g_K (V_K - V) + g_L (V_L - V) + I_{stim}$$

$$C \frac{dV}{dt} = \underbrace{g_{Na} V_{Na} + g_K V_K + g_L V_L}_{G_{tot}} - \underbrace{(g_{Na} + g_K + g_L)}_{G_{tot}} V + I_{stim}$$

$$C \frac{dV}{dt} = G_{tot} (V_0 - V) + I_{stim}$$

$$\tau = \frac{C}{G_{tot}}$$

$$\tau \frac{dV}{dt} = (V_0 - V) + \frac{I_{stim}}{G_{tot}}$$

# Integrate-and-Fire model : membrane potential equation

$$\tau \frac{dV}{dt} = (V_0 - V) + \frac{I_{ext}}{G_{tot}}$$

- $V_0$  resting membrane potential
- $\tau$  membrane time constant
- $I_{ext}$  external current (synaptic)
- $G_{tot}$  total conductance

## generation of the action potential :

- $\Theta$  firing threshold
- $V_r$  reset potential
- if  $V > \Theta$  :
  - the neuron fires an action potential
  - after the action potential, the membrane potential is reset to  $V_r$

# Integrate-and-Fire model : dynamics

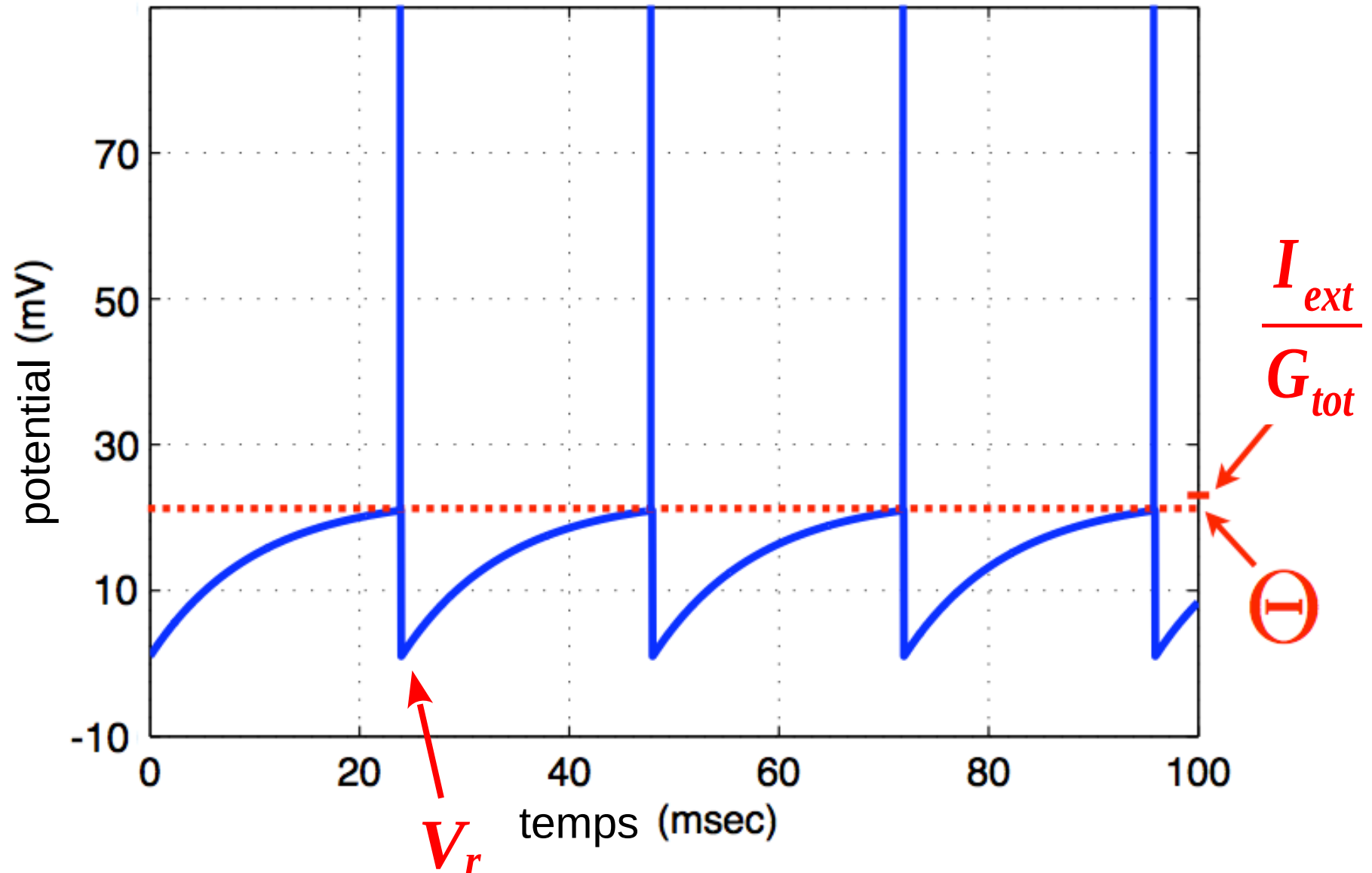



# Integrate-and-Fire model : dynamics

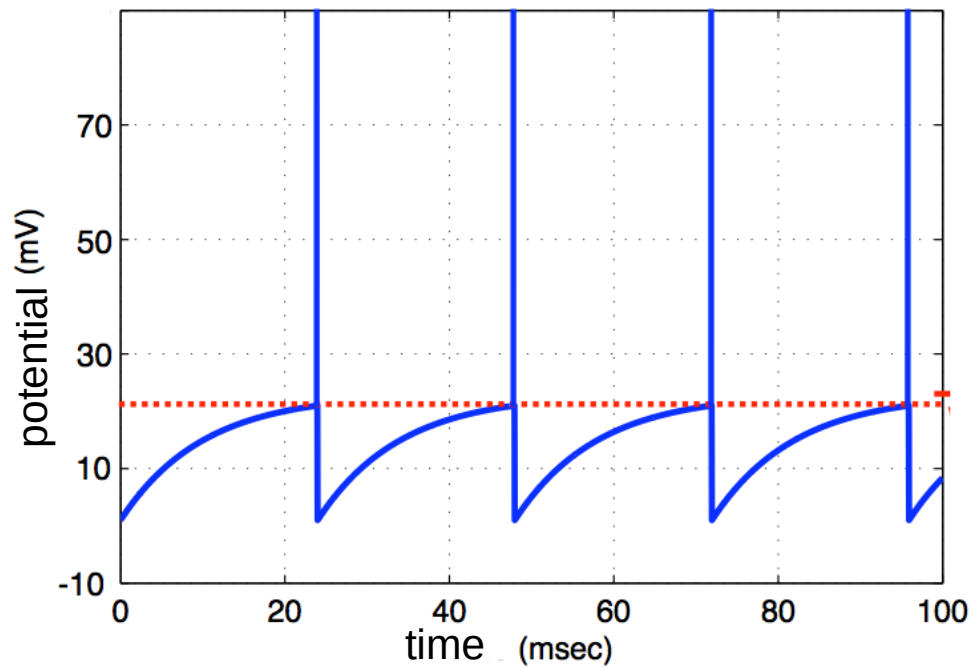

F-I curve

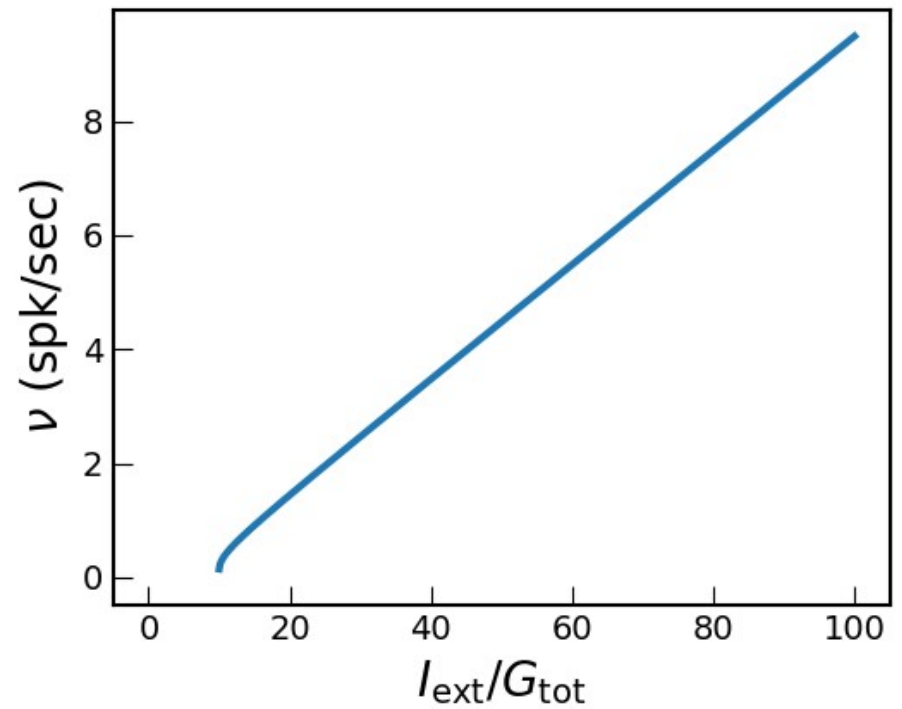

# Rate neuron model

Phenomenological description of the input-output function :

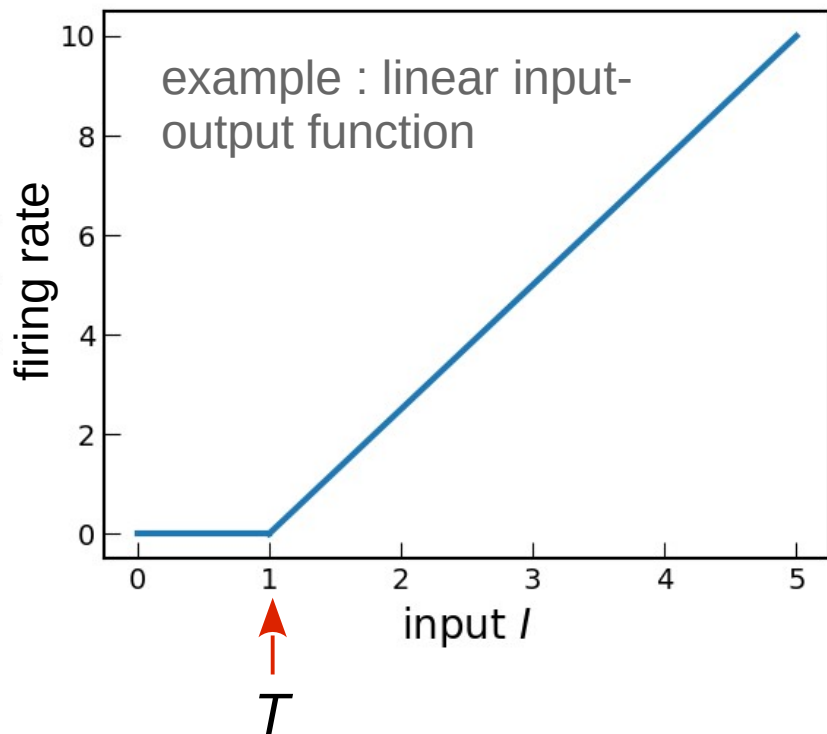

$$\tau \frac{dm}{dt} = -m + F(I_{syn} + I_{ext} - T)$$

$m$ : output of the neuron – firing rate

$\tau$  : membrane time constant

$F$  : input-output transfer function

$I_{syn}$ : synaptic input

$I_{ext}$ : external current

$T$  : firing threshold

# How do potentials propagate along the dendritic tree ?

$V(t)$

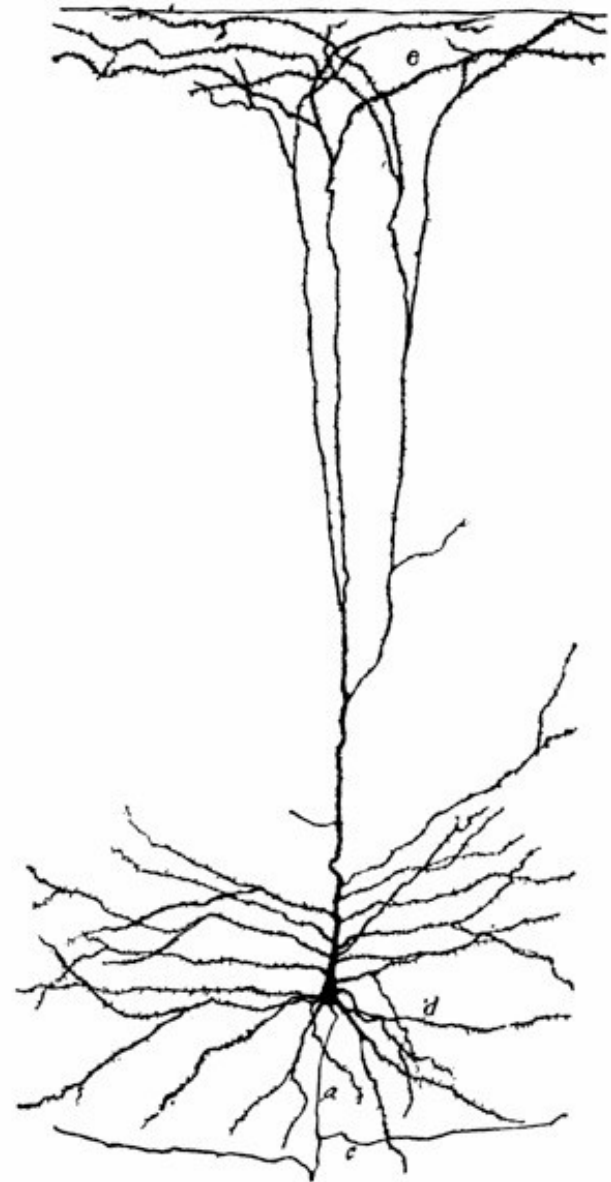

# Cable theory

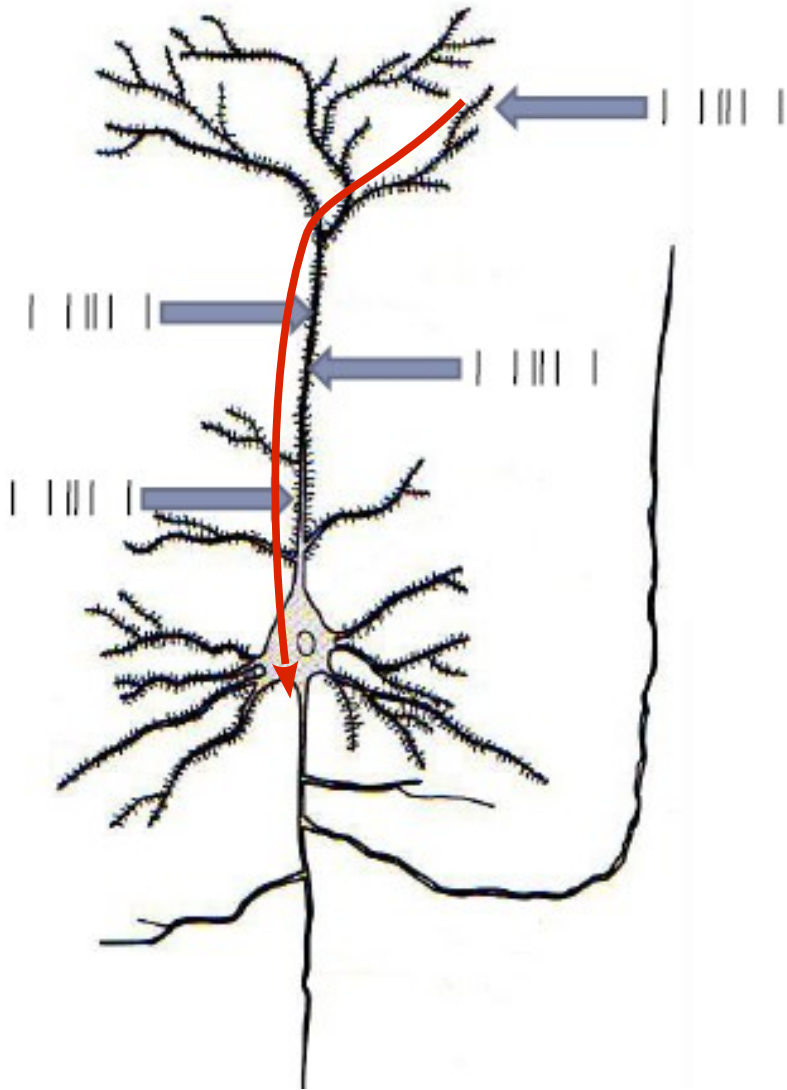

- how do synaptic inputs propagate to the soma or the axon initial segment
- how do input interact between each other
- how does the input location along the dendritic tree impact its functional importance for the neuron

# Abstraction of the dendritic membrane of a neuron

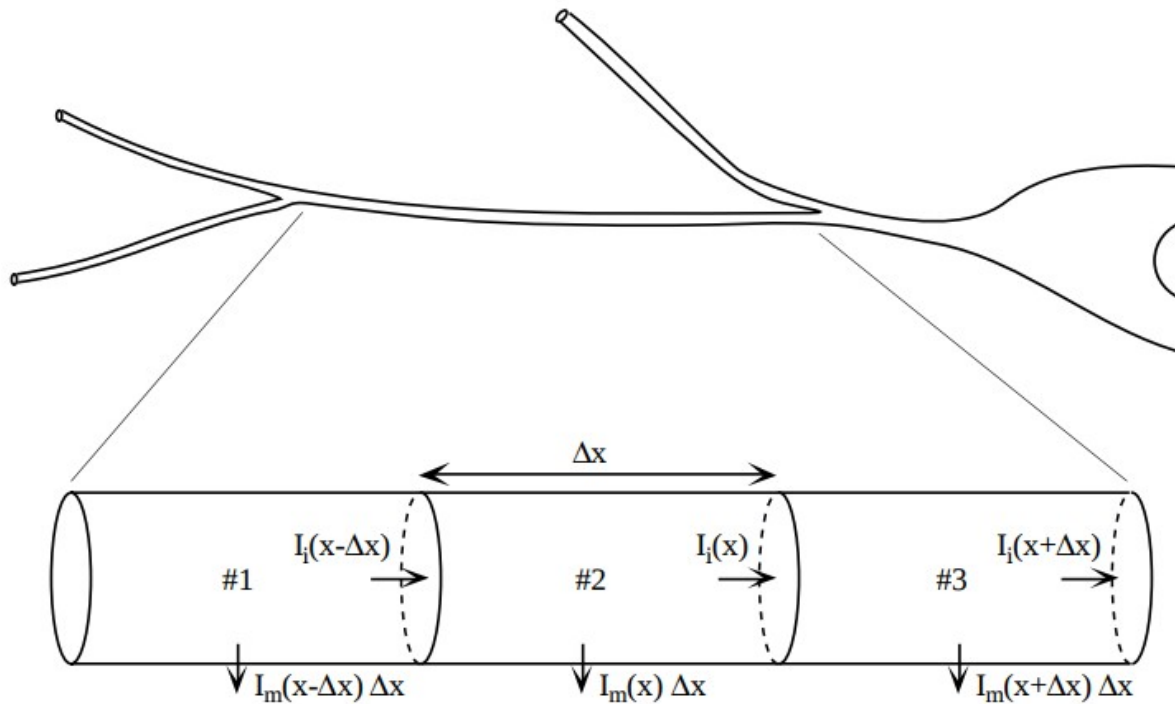

Soma and dendritic branch

Portion of the secondary dendrite divided in three sub-cylinders

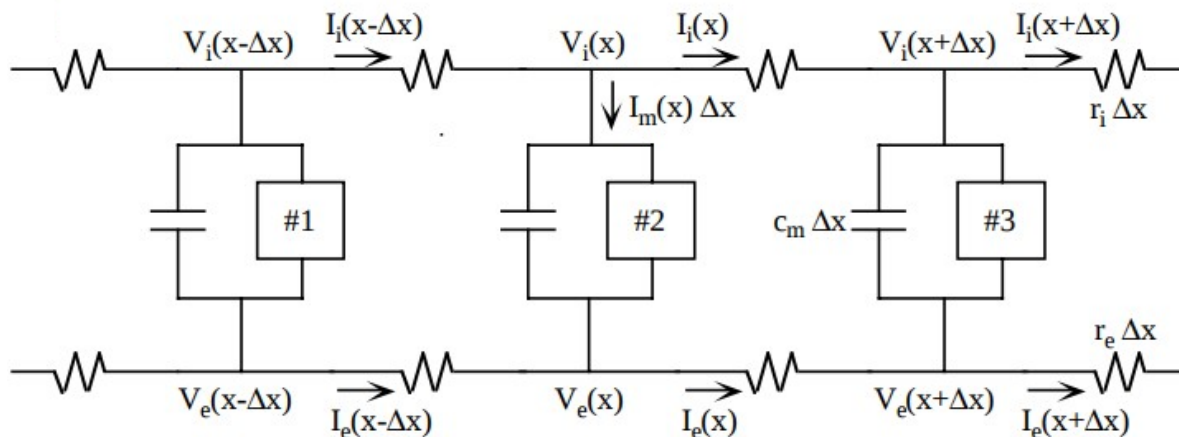

Discrete electric model of the three sub-cylinders

# Non-linear cable equation

models the membrane potential distribution along a membrane cylinder

$$V(t) \rightarrow V(x,t)$$

$$\frac{1}{r_i + r_e} \frac{\partial V}{\partial x^2} = c_m \frac{\partial V}{\partial t} + I_{ion}$$

current which propagates  
between neighboring points  
along the cylinder

typical membrane potential  
equation of the point neuron  
model

# Stationary solution of the cable equation

$$I_{ext}(t, x) = \delta(x)$$

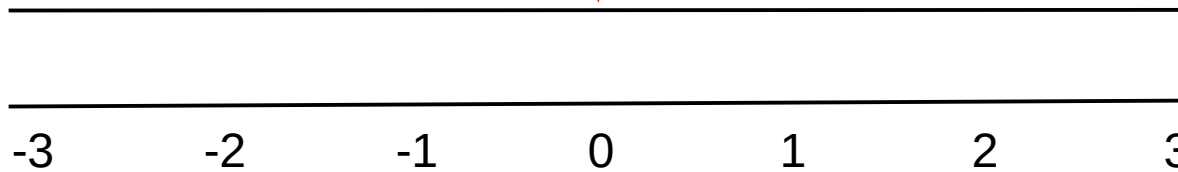

infinite cable  
(open ends)

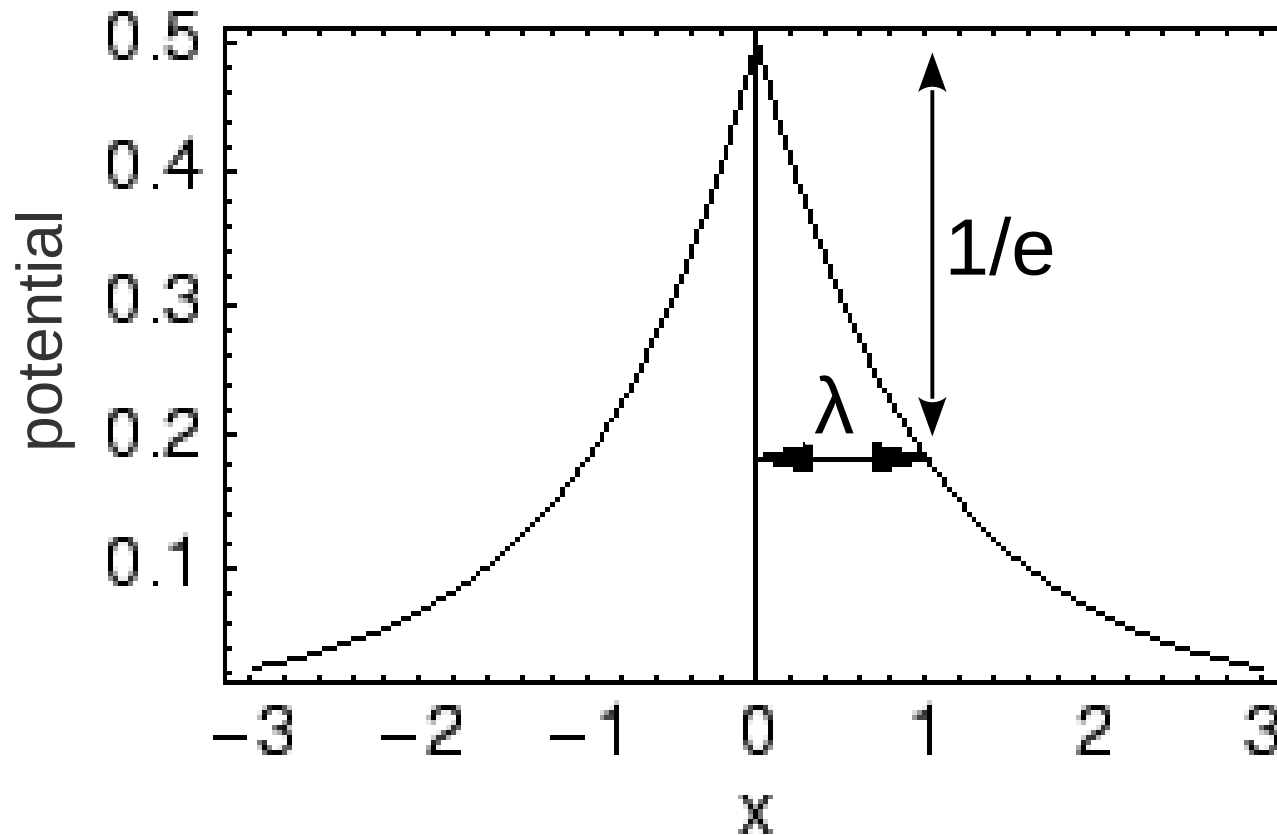

$\lambda$  electrotonic  
length constant

# Spatial and temporal distribution of the potential along the membrane

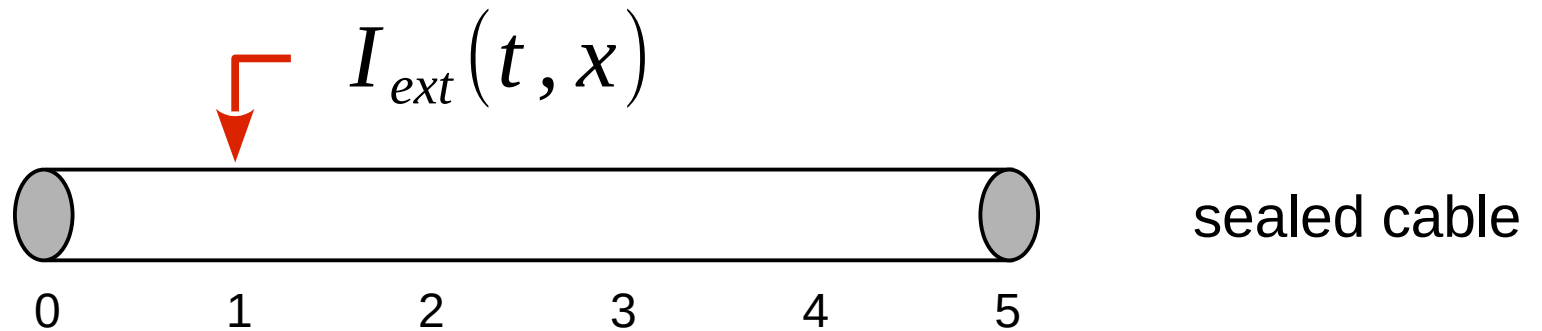

different time points

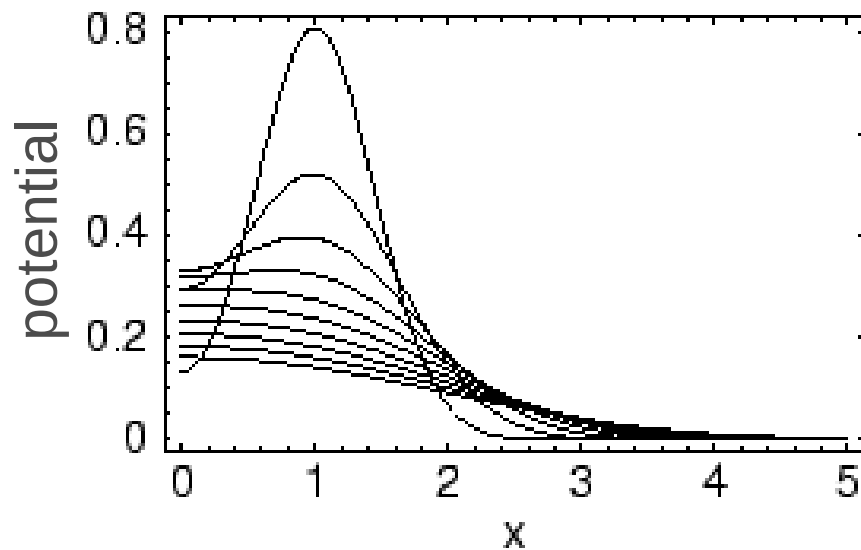

$t = 0.1, 0.2, \dots, 1.0$

different locations

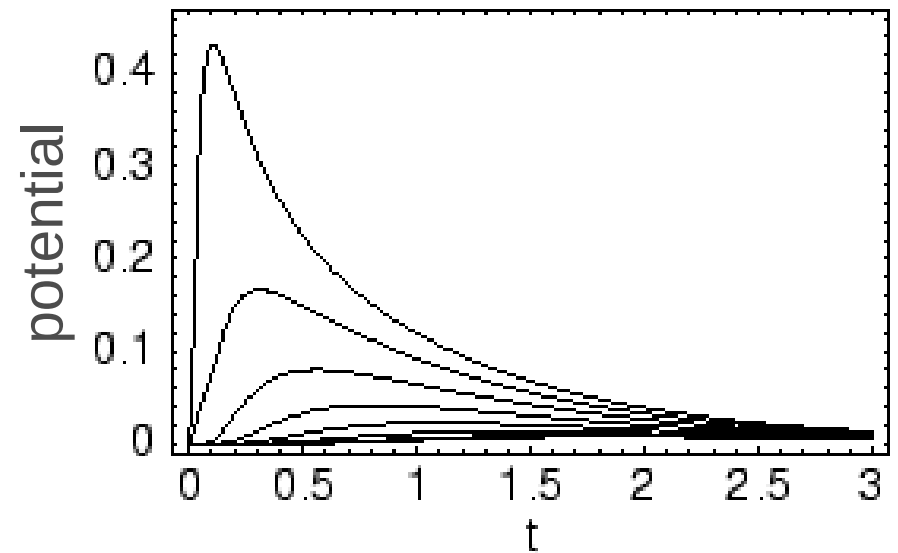

$x = 1.5, 2.0, 2.5, \dots, 5.0$



# Cable theory and compartmental modeling

**Cable theory** consists of solving the partial differential equation

$$\frac{1}{r_i + r_e} \frac{\partial V}{\partial x^2} = c_m \frac{\partial V}{\partial t} + I_{ion}$$

- a few cases with analytical solutions
- generally solved using numerical simulations

## Compartmental modeling

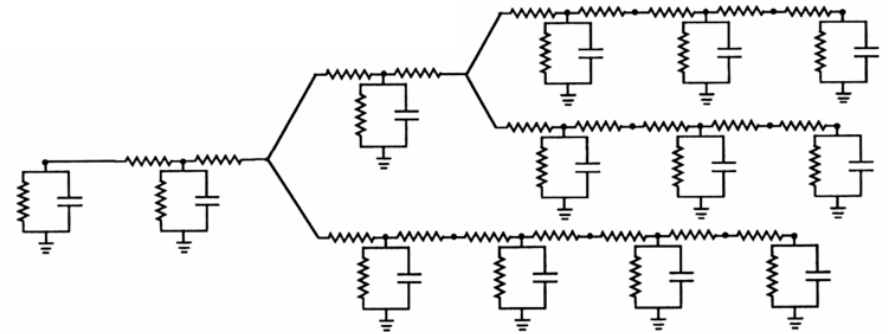

- discretize space → coupled system of ordinary differential equations (with temporal derivative)
- easier to solve numerically
- typically done using the Neuron software

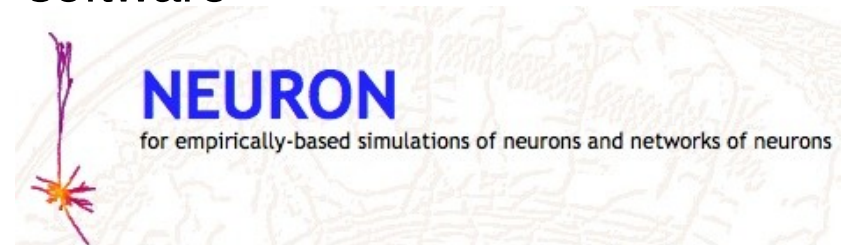

# Single neuron models

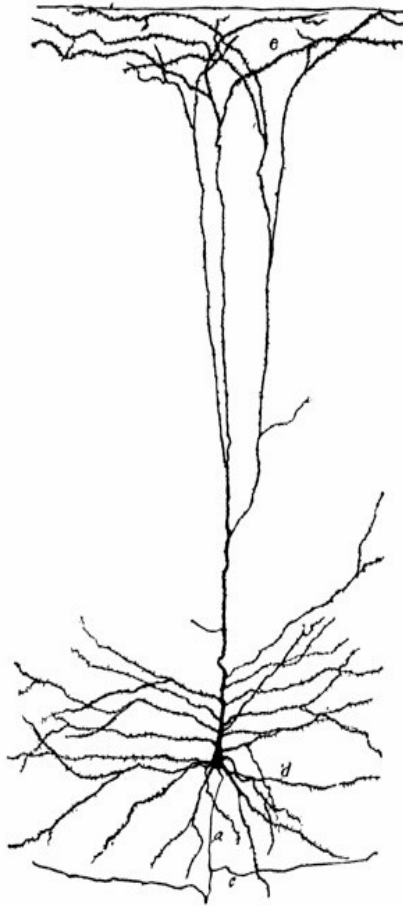

real  
neuron

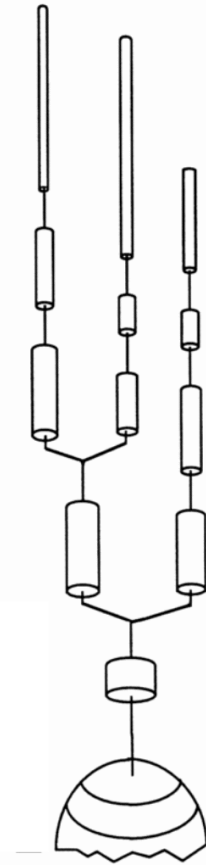

cable  
theory

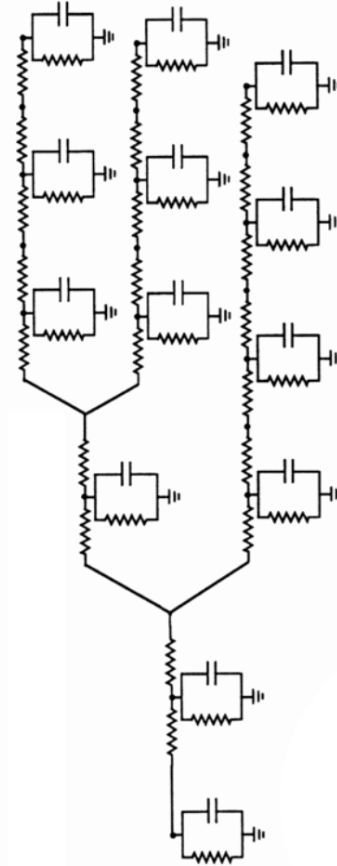

compartmental  
model

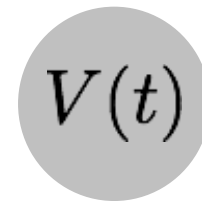

point  
neuron

# Resources for further reading

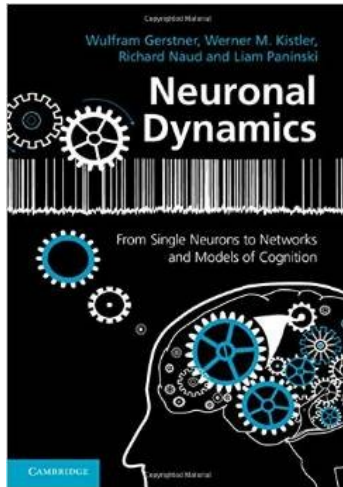

## Neuronal Dynamics

From single neurons to networks and models of cognition

Wulfram Gerstner, Werner M. Kistler, Richard Naud and Liam Paninski

online book : <https://neurondynamics.epfl.ch/online/index.html>

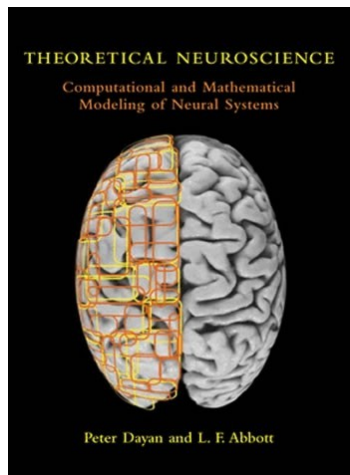

## Theoretical Neuroscience

Computational and Mathematical Modeling of Neural Systems

Peter Dayan and L. F. Abbott

online book : <http://www.gatsby.ucl.ac.uk/~limate/biblio/dayanabbott.pdf>